

# COMPUTER NETWORKS

## Lecture Notes

JNTU World

## UNIT -I

### Introduction to Computer Networks

**1.1 Data Communication:** When we communicate, we are sharing information. This sharing can be local or remote. Between individuals, local communication usually occurs face to face, while remote communication takes place over distance.

#### 1.1.1 Components:

A data communications system has five components.

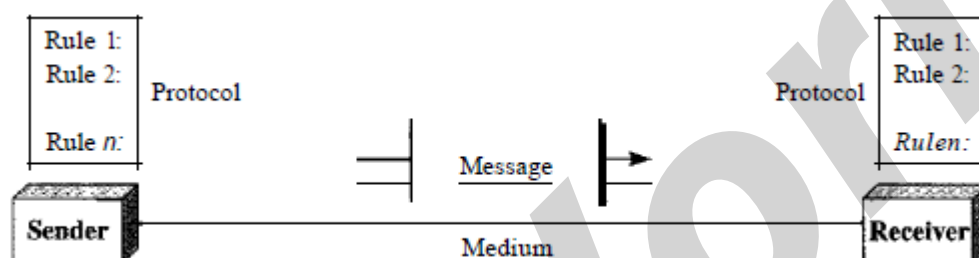

1. Message. The message is the information (data) to be communicated. Popular forms of information include text, numbers, pictures, audio, and video.
2. Sender. The sender is the device that sends the data message. It can be a computer, workstation, telephone handset, video camera, and so on.
3. Receiver. The receiver is the device that receives the message. It can be a computer, workstation, telephone handset, television, and so on.
4. Transmission medium. The transmission medium is the physical path by which a message travels from sender to receiver. Some examples of transmission media include twisted-pair wire, coaxial cable, fiber-optic cable, and radio waves
5. Protocol. A protocol is a set of rules that govern data communications. It represents an agreement between the communicating devices. Without a protocol, two devices may be connected but not communicating, just as a person speaking French cannot be understood by a person who speaks only Japanese.

### 1.1.2 Data Representation:

Information today comes in different forms such as text, numbers, images, audio, and video.

#### *Text:*

In data communications, text is represented as a bit pattern, a sequence of bits (Os or Is). Different sets of bit patterns have been designed to represent text symbols. Each set is called a code, and the process of representing symbols is called coding. Today, the prevalent coding system is called Unicode, which uses 32 bits to represent a symbol or character used in any language in the world. The American Standard Code for Information Interchange (ASCII), developed some decades ago in the United States, now constitutes the first 127 characters in Unicode and is also referred to as Basic Latin.

#### *Numbers:*

Numbers are also represented by bit patterns. However, a code such as ASCII is not used to represent numbers; the number is directly converted to a binary number to simplify mathematical operations. Appendix B discusses several different numbering systems.

#### *Images:*

Images are also represented by bit patterns. In its simplest form, an image is composed of a matrix of pixels (picture elements), where each pixel is a small dot. The size of the pixel depends on the *resolution*. For example, an image can be divided into 1000 pixels or 10,000 pixels. In the second case, there is a better representation of the image (better resolution), but more memory is needed to store the image. After an image is divided into pixels, each pixel is assigned a bit pattern. The size and the value of the pattern depend on the image. For an image made of only black and white dots (e.g., a chessboard), a 1-bit pattern is enough to represent a pixel. If an image is not made of pure white and pure black pixels, you can increase the size of the bit pattern to include gray scale. For example, to show four levels of gray scale, you can use 2-bit patterns. A black pixel can be represented by 00, a dark gray pixel by 01, a light gray pixel by 10, and a white pixel by 11. There are several methods to represent color images. One method is called RGB, so called because each color is made of a combination of three primary colors: *red*, *green*, and *blue*. The intensity of each color is measured, and a bit pattern is assigned to it. Another method is called YCM, in which a color is made of a combination of three other primary colors: *yellow*, *cyan*, and *magenta*.

#### *Audio:*

Audio refers to the recording or broadcasting of sound or music. Audio is by nature different from text, numbers, or images. It is continuous, not discrete. Even when we use a microphone to change voice or music to an electric signal, we create a continuous signal. In Chapters 4 and 5, we learn how to change sound or music to a digital or an analog signal.

*Video:*

Video refers to the recording or broadcasting of a picture or movie. Video can either be produced as a continuous entity (e.g., by a TV camera), or it can be a combination of images, each a discrete entity, arranged to convey the idea of motion. Again we can change video to a digital or an analog signal.

### 1.1.3 Data Flow

Communication between two devices can be simplex, half-duplex, or full-duplex as shown in Figure



a. Simplex

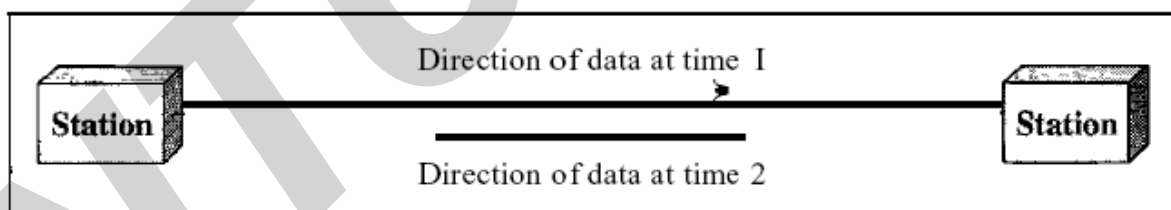

b. Half-duplex

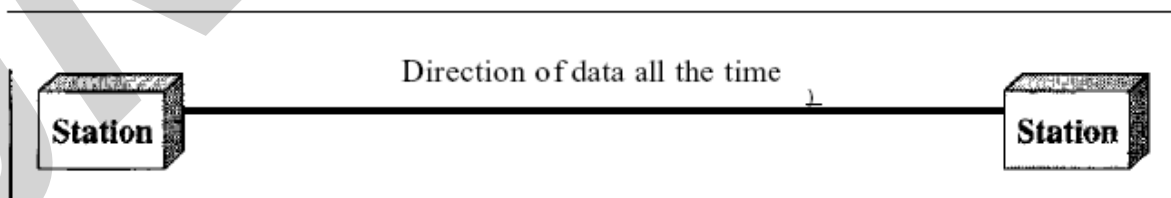

c. Full-duplex

### *Simplex:*

In simplex mode, the communication is unidirectional, as on a one-way street. Only one of the two devices on a link can transmit; the other can only receive (see Figure a). Keyboards and traditional monitors are examples of simplex devices. The keyboard can only introduce input; the monitor can only accept output. The simplex mode can use the entire capacity of the channel to send data in one direction.

### *Half-Duplex:*

In half-duplex mode, each station can both transmit and receive, but not at the same time. When one device is sending, the other can only receive, and vice versa. The half-duplex mode is like a one-lane road with traffic allowed in both directions.

When cars are traveling in one direction, cars going the other way must wait. In a half-duplex transmission, the entire capacity of a channel is taken over by whichever of the two devices is transmitting at the time. Walkie-talkies and CB (citizens band) radios are both half-duplex systems.

The half-duplex mode is used in cases where there is no need for communication in both directions at the same time; the entire capacity of the channel can be utilized for each direction.

### *Full-Duplex:*

In full-duplex both stations can transmit and receive simultaneously (see Figure c). The full-duplex mode is like a two-way street with traffic flowing in both directions at the same time. In full-duplex mode, signals going in one direction share the capacity of the link: with signals going in the other direction. This sharing can occur in two ways: Either the link must contain two physically separate transmission paths, one for sending and the other for receiving; or the capacity of the channel is divided between signals traveling in both directions. One common example of full-duplex communication is the telephone network. When two people are communicating by a telephone line, both can talk and listen at the same time. The full-duplex mode is used when communication in both directions is required all the time. The capacity of the channel, however, must be divided between the two directions.

## 1.2 NETWORKS

A network is a set of devices (often referred to as *nodes*) connected by communication links. A node can be a computer, printer, or any other device capable of sending and/or receiving data generated by other nodes on the network.

### 1.2.1 Distributed Processing

Most networks use distributed processing, in which a task is divided among multiple computers. Instead of one single large machine being responsible for all aspects of a process, separate computers (usually a personal computer or workstation) handle a subset.

### 1.2.2 Network Criteria

A network must be able to meet a certain number of criteria. The most important of these are performance, reliability, and security.

#### *Performance:*

Performance can be measured in many ways, including transit time and response time. Transit time is the amount of time required for a message to travel from one device to another. Response time is the elapsed time between an inquiry and a response. The performance of a network depends on a number of factors, including the number of users, the type of transmission medium, the capabilities of the connected hardware, and the efficiency of the software. Performance is often evaluated by two networking metrics: throughput and delay. We often need more throughput and less delay. However, these two criteria are often contradictory. If we try to send more data to the network, we may increase throughput but we increase the delay because of traffic congestion in the network.

#### *Reliability:*

In addition to accuracy of delivery, network reliability is measured by the frequency of failure, the time it takes a link to recover from a failure, and the network's robustness in a catastrophe.

#### *Security:*

Network security issues include protecting data from unauthorized access, protecting data from damage and development, and implementing policies and procedures for recovery from breaches and data losses.

### 1.2.3 Physical Structures:

#### Type of Connection

A network is two or more devices connected through links. A link is a communications pathway that transfers data from one device to another. For visualization purposes, it is simplest to imagine any link as a line drawn between two points. For communication to occur, two devices must be connected in some way to the same link at the same time. There are two possible types of connections: point-to-point and multipoint.

#### Point-to-Point

A point-to-point connection provides a dedicated link between two devices. The entire capacity of the link is reserved for transmission between those two devices. Most point-to-point connections use an actual length of wire or cable to connect the two ends, but other options, such as microwave or satellite links, are also possible. When you change television channels by infrared remote control, you are establishing a point-to-point connection between the remote control and the television's control system.

#### Multipoint

A multipoint (also called multidrop) connection is one in which more than two specific devices share a single link. In a multipoint environment, the capacity of the channel is shared, either spatially or temporally. If several devices can use the link simultaneously, it is a *spatially shared* connection. If users must take turns, it is a *timeshared* connection.

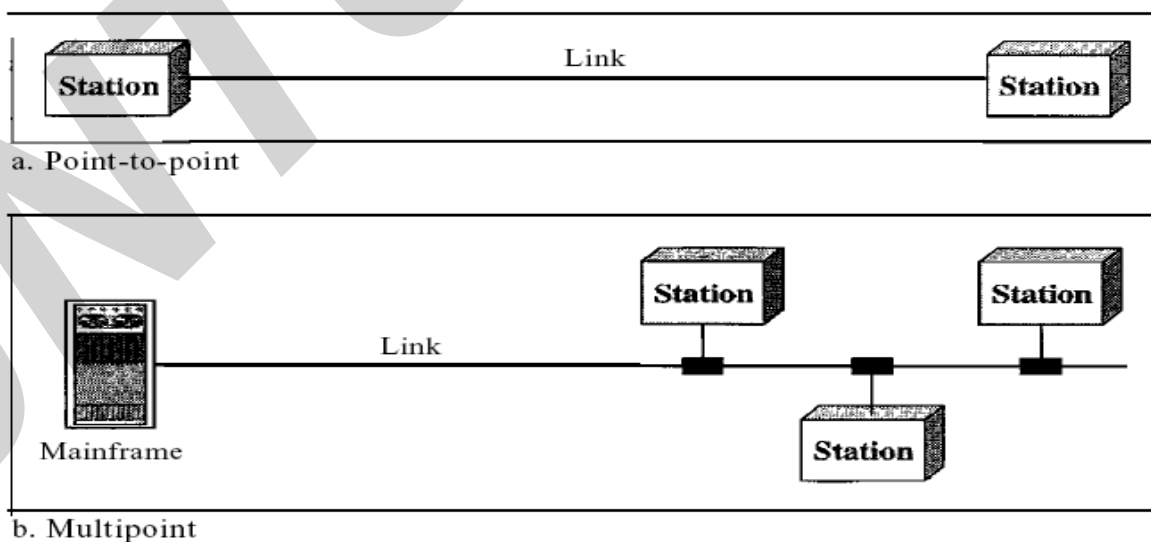

### 1.2.3.1 Physical Topology

The term *physical topology* refers to the way in which a network is laid out physically. One or more devices connect to a link; two or more links form a topology. The topology of a network is the geometric representation of the relationship of all the links and linking devices (usually called nodes) to one another. There are four basic topologies possible: mesh, star, bus, and ring

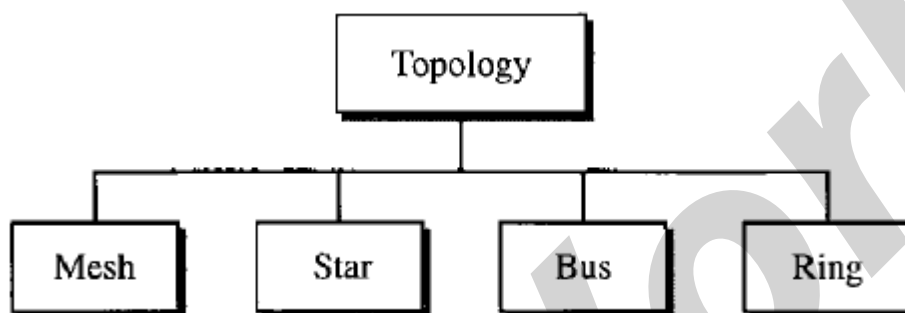

**Mesh:** In a mesh topology, every device has a dedicated point-to-point link to every other device. The term *dedicated* means that the link carries traffic only between the two devices it connects. To find the number of physical links in a fully connected mesh network with  $n$  nodes, we first consider that each node must be connected to every other node. Node 1 must be connected to  $n - 1$  nodes, node 2 must be connected to  $n - 1$  nodes, and finally node  $n$  must be connected to  $n - 1$  nodes. We need  $n(n - 1)$  physical links. However, if each physical link allows communication in both directions (duplex mode), we can divide the number of links by 2. In other words, we can say that in a mesh topology, we need  $n(n - 1) / 2$  duplex-mode links.

To accommodate that many links, every device on the network must have  $n - 1$  input/output (VO) ports to be connected to the other  $n - 1$  stations.

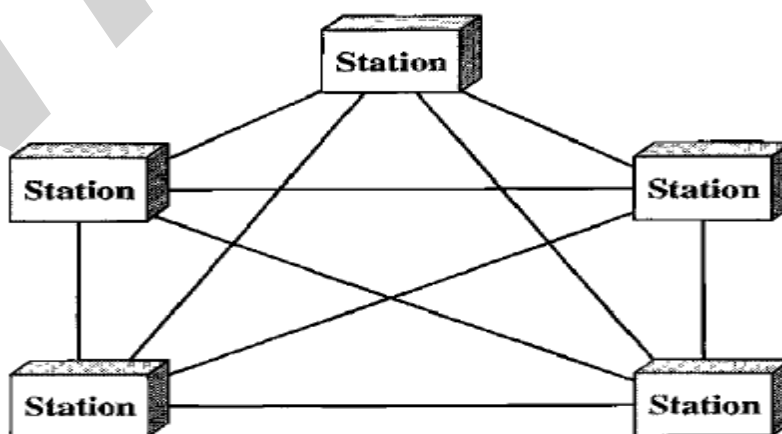



#### Advantages:

1. The use of dedicated links guarantees that each connection can carry its own data load, thus eliminating the traffic problems that can occur when links must be shared by multiple devices.
2. A mesh topology is robust. If one link becomes unusable, it does not incapacitate the entire system. Third, there is the advantage of privacy or security. When every message travels along a dedicated line, only the intended recipient sees it. Physical boundaries prevent other users from gaining access to messages. Finally, point-to-point links make fault identification and fault isolation easy. Traffic can be routed to avoid links with suspected problems. This facility enables the network manager to discover the precise location of the fault and aids in finding its cause and solution.

#### Disadvantages:

1. Disadvantage of a mesh are related to the amount of cabling because every device must be connected to every other device, installation and reconnection are difficult.
2. Second, the sheer bulk of the wiring can be greater than the available space (in walls, ceilings, or floors) can accommodate. Finally, the hardware required to connect each link (I/O ports and cable) can be prohibitively expensive.

For these reasons a mesh topology is usually implemented in a limited fashion, for example, as a backbone connecting the main computers of a hybrid network that can include several other topologies.

#### **Star Topology:**

In a star topology, each device has a dedicated point-to-point link only to a central controller, usually called a hub. The devices are not directly linked to one another. Unlike a mesh topology, a star topology does not allow direct traffic between devices. The controller acts as an exchange: If one device wants to send data to another, it sends the data to the controller, which then relays the data to the other connected device .

A star topology is less expensive than a mesh topology. In a star, each device needs only one link and one I/O port to connect it to any number of others. This factor also makes it easy to install and reconfigure. Far less cabling needs to be housed, and additions, moves, and deletions involve only one connection: between that device and the hub.

Other advantages include robustness. If one link fails, only that link is affected. All other links remain active. This factor also lends itself to easy fault identification and fault isolation. As long as the hub is working, it can be used to monitor link problems and bypass defective links.

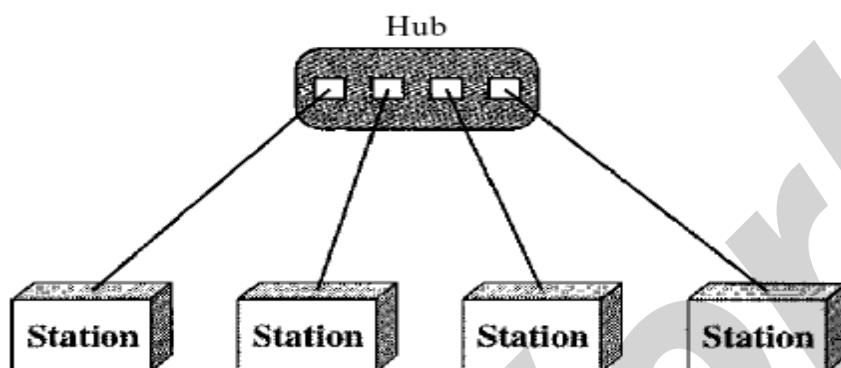

One big disadvantage of a star topology is the dependency of the whole topology on one single point, the hub. If the hub goes down, the whole system is dead. Although a star requires far less cable than a mesh, each node must be linked to a central hub. For this reason, often more cabling is required in a star than in some other topologies (such as ring or bus).

### Bus Topology:

The preceding examples all describe point-to-point connections. A **bus topology**, on the other hand, is multipoint. One long cable acts as a **backbone** to link all the devices in a network

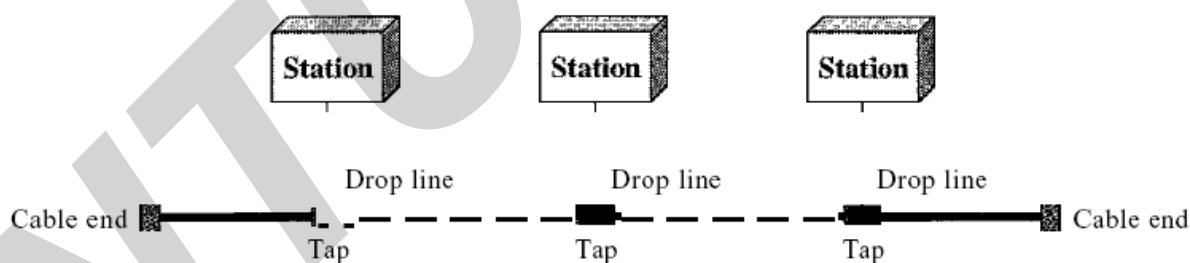

Nodes are connected to the bus cable by drop lines and taps. A drop line is a connection running between the device and the main cable. A tap is a connector that either splices into the main cable or punctures the sheathing of a cable to create a contact with the metallic core. As a signal travels along the backbone, some of its energy is transformed into heat. Therefore, it becomes weaker and weaker as it travels farther and farther. For this reason there is a limit on the number of taps a bus can support and on the distance between those taps.

Advantages of a bus topology include ease of installation. Backbone cable can be laid along the most efficient path, then connected to the nodes by drop lines of various lengths. In this way, a bus uses less cabling than mesh or star topologies. In a star, for example, four network devices in the same room require four lengths of cable reaching all the way to the hub. In a bus, this redundancy is eliminated. Only the backbone cable stretches through the entire facility. Each drop line has to reach only as far as the nearest point on the backbone.

Disadvantages include difficult reconnection and fault isolation. A bus is usually designed to be optimally efficient at installation. It can therefore be difficult to add new devices. Signal reflection at the taps can cause degradation in quality. This degradation can be controlled by limiting the number and spacing of devices connected to a given length of cable. Adding new devices may therefore require modification or replacement of the backbone.

In addition, a fault or break in the bus cable stops all transmission, even between devices on the same side of the problem. The damaged area reflects signals back in the direction of origin, creating noise in both directions.

Bus topology was the one of the first topologies used in the design of early local area networks. Ethernet LANs can use a bus topology, but they are less popular.

**Ring Topology** In a ring topology, each device has a dedicated point-to-point connection with only the two devices on either side of it. A signal is passed along the ring in one direction, from device to device, until it reaches its destination. Each device in the ring incorporates a repeater. When a device receives a signal intended for another device, its repeater regenerates the bits and passes them along

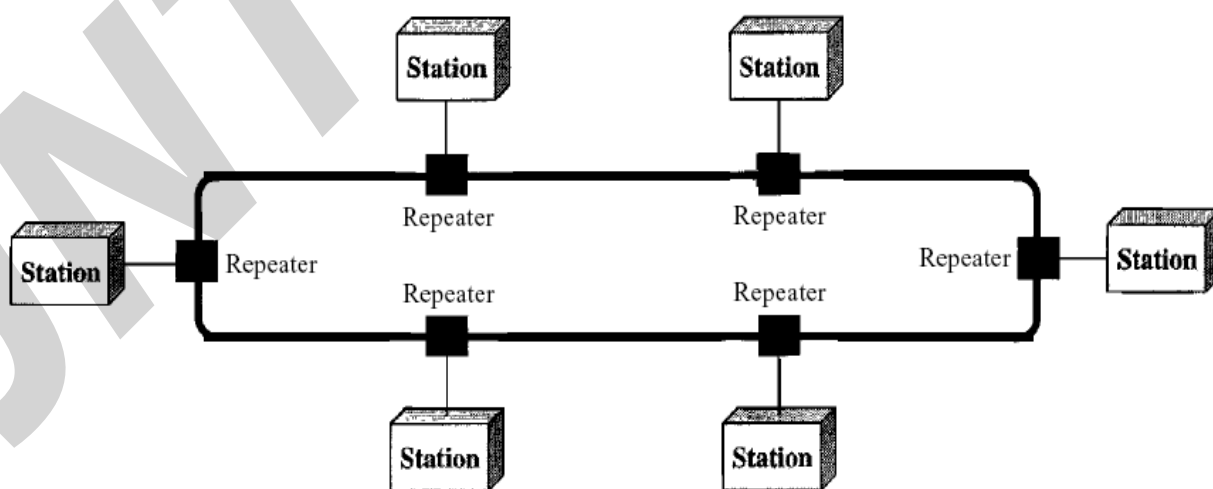

A ring is relatively easy to install and reconfigure. Each device is linked to only its immediate neighbors (either physically or logically). To add or delete a device requires changing only two connections. The only constraints are media and traffic considerations (maximum ring length and number of devices). In addition, fault isolation is simplified. Generally in a ring, a signal is circulating at all times. If one device does not receive a signal within a specified period, it can issue an alarm. The alarm alerts the network operator to the problem and its location.

However, unidirectional traffic can be a disadvantage. In a simple ring, a break in the ring (such as a disabled station) can disable the entire network. This weakness can be solved by using a dual ring or a switch capable of closing off the break. Ring topology was prevalent when IBM introduced its local-area network Token Ring. Today, the need for higher-speed LANs has made this topology less popular. Hybrid Topology A network can be hybrid. For example, we can have a main star topology with each branch connecting several stations in a bus topology as shown in Figure

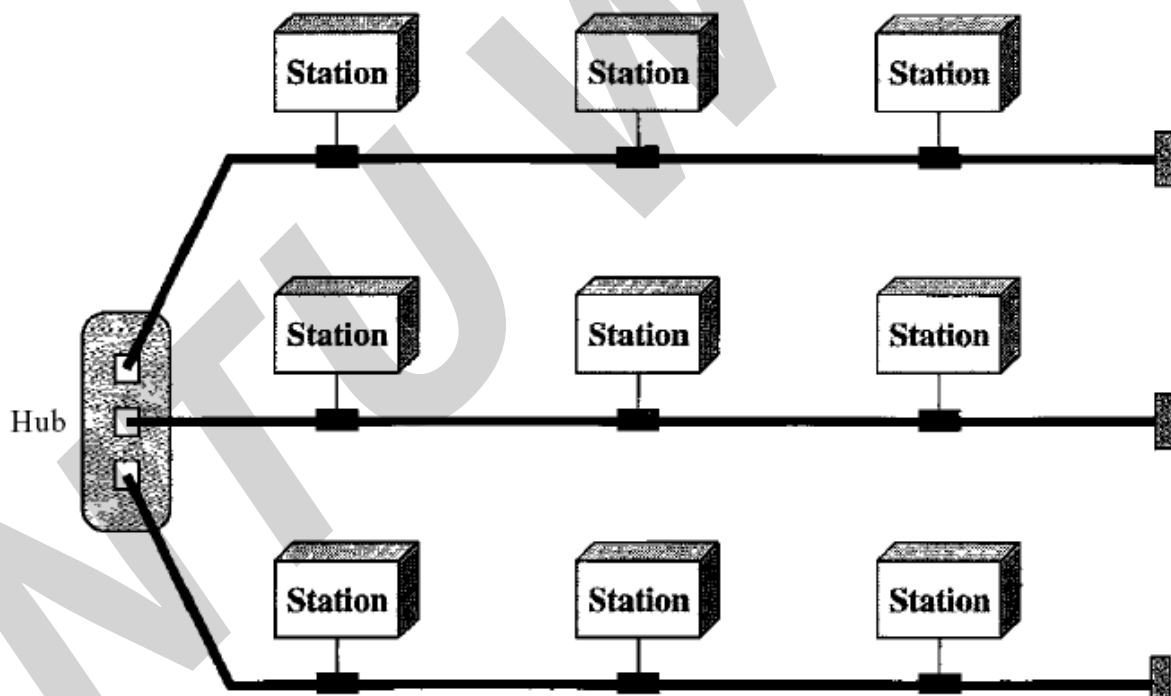

## 1.2.4 Categories of Networks

### Local Area Networks:

Local area networks, generally called LANs, are privately-owned networks within a single building or campus of up to a few kilometres in size. They are widely used to connect personal computers and workstations in company offices and factories to share resources (e.g., printers) and exchange information. LANs are distinguished from other kinds of networks by three characteristics:

- (1) Their size,
- (2) Their transmission technology, and
- (3) Their topology.

LANs are restricted in size, which means that the worst-case transmission time is bounded and known in advance. Knowing this bound makes it possible to use certain kinds of designs that would not otherwise be possible. It also simplifies network management. LANs may use a transmission technology consisting of a cable to which all the machines are attached, like the telephone company party lines once used in rural areas. Traditional LANs run at speeds of 10 Mbps to 100 Mbps, have low delay (microseconds or nanoseconds), and make very few errors. Newer LANs operate at up to 10 Gbps. Various topologies are possible for broadcast LANs. Figure 1 shows two of them. In a bus (i.e., a linear cable) network, at any instant at most one machine is the master and is allowed to transmit. All other machines are required to refrain from sending. An arbitration mechanism is needed to resolve conflicts when two or more machines want to transmit simultaneously. The arbitration mechanism may be centralized or distributed. IEEE 802.3, popularly called Ethernet, for example, is a bus-based broadcast network with decentralized control, usually operating at 10 Mbps to 10 Gbps. Computers on an Ethernet can transmit whenever they want to; if two or more packets collide, each computer just waits a random time and tries again later.

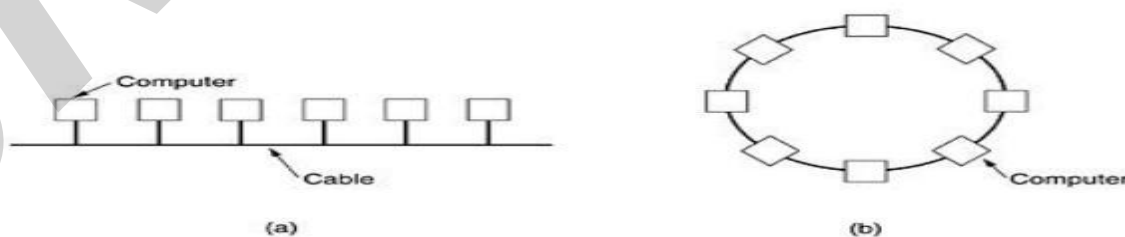

**Fig.1: Two broadcast networks . (a) Bus. (b) Ring.**

A second type of broadcast system is the ring. In a ring, each bit propagates around on its own, not waiting for the rest of the packet to which it belongs. Typically, each bit circumnavigates the entire ring in the time it takes to transmit a few bits, often before the complete packet has even been transmitted. As with all other broadcast systems, some rule is needed for arbitrating simultaneous accesses to the ring. Various methods, such as having the machines take turns, are in use. IEEE 802.5 (the IBM token ring), is a ring-based LAN operating at 4 and 16 Mbps. FDDI is another example of a ring network.

### **Metropolitan Area Network (MAN):**

#### **Metropolitan Area Network:**

A metropolitan area network, or MAN, covers a city. The best-known example of a MAN is the cable television network available in many cities. This system grew from earlier community antenna systems used in areas with poor over-the-air television reception. In these early systems, a large antenna was placed on top of a nearby hill and signal was then piped to the subscribers' houses. At first, these were locally-designed, ad hoc systems. Then companies began jumping into the business, getting contracts from city governments to wire up an entire city. The next step was television programming and even entire channels designed for cable only. Often these channels were highly specialized, such as all news, all sports, all cooking, all gardening, and so on. But from their inception until the late 1990s, they were intended for television reception only. To a first approximation, a MAN might look something like the system shown in Fig. In this figure both television signals and Internet are fed into the centralized head end for subsequent distribution to people's homes. Cable television is not the only MAN. Recent developments in high-speed wireless Internet access resulted in another MAN, which has been standardized as IEEE 802.16.

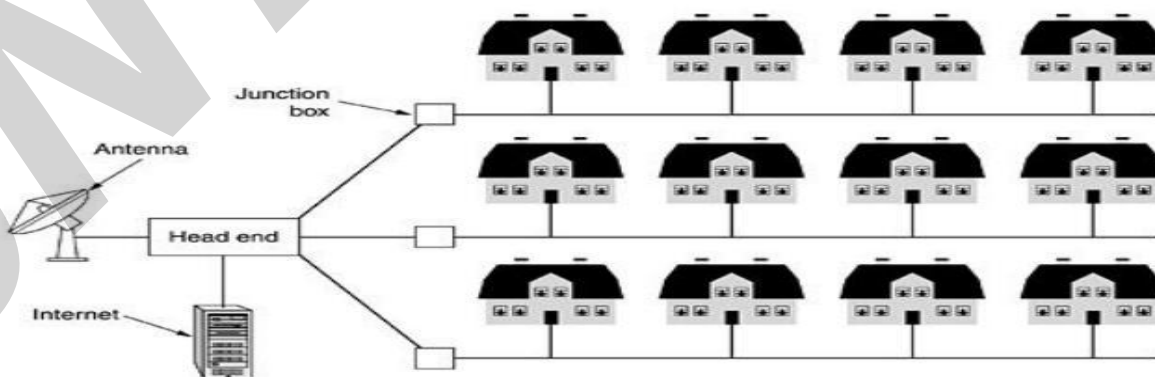

**Fig.2: Metropolitan area network based on cable TV.**

A MAN is implemented by a standard called DQDB (Distributed Queue Dual Bus) or IEEE 802.16. DQDB has two unidirectional buses (or cables) to which all the computers are attached.

### **Wide Area Network (WAN).**

#### **Wide Area Network:**

A wide area network, or WAN, spans a large geographical area, often a country or continent. It contains a collection of machines intended for running user (i.e., application) programs. These machines are called as hosts. The hosts are connected by a communication subnet, or just subnet for short. The hosts are owned by the customers (e.g., people's personal computers), whereas the communication subnet is typically owned and operated by a telephone company or Internet service provider. The job of the subnet is to carry messages from host to host, just as the telephone system carries words from speaker to listener.

Separation of the pure communication aspects of the network (the subnet) from the application aspects (the hosts), greatly simplifies the complete network design. In most wide area networks, the subnet consists of two distinct components: transmission lines and switching elements. Transmission lines move bits between machines. They can be made of copper wire, optical fiber, or even radio links. In most WANs, the network contains numerous transmission lines, each one connecting a pair of routers. If two routers that do not share a transmission line wish to communicate, they must do this indirectly, via other routers. When a packet is sent from one router to another via one or more intermediate routers, the packet is received at each intermediate router in its entirety, stored there until the required output line is free, and then forwarded. A subnet organized according to this principle is called a store-and-forward or packet-switched subnet. Nearly all wide area networks (except those using satellites) have store-and-forward subnets. When the packets are small and all the same size, they are often called cells.

The principle of a packet-switched WAN is so important. Generally, when a process on some host has a message to be sent to a process on some other host, the sending host first cuts the message into packets, each one bearing its number in the sequence. These packets are then injected into the network one at a time in quick succession. The packets are transported individually over the network and deposited at the receiving host, where they are reassembled into the original message and delivered to the receiving process. A stream of packets resulting from some initial message is illustrated in Fig.

In this figure, all the packets follow the route ACE, rather than ABDE or ACDE. In some networks all packets from a given message must follow the same route; in others each packet is routed separately. Of course, if ACE is the best route, all packets may be sent along it, even if each packet is individually routed.

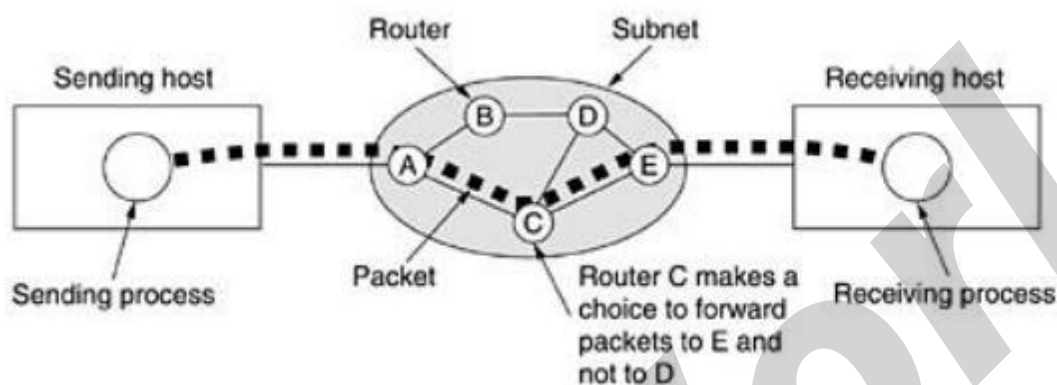

**Fig.3.1: A stream of packets from sender to receiver.**

Not all WANs are packet switched. A second possibility for a WAN is a satellite system. Each router has an antenna through which it can send and receive. All routers can hear the output from the satellite, and in some cases they can also hear the upward transmissions of their fellow routers to the satellite as well. Sometimes the routers are connected to a substantial point-to-point subnet, with only some of them having a satellite antenna. Satellite networks are inherently broadcast and are most useful when the broadcast property is important.

### 1.3 THE INTERNET

The Internet has revolutionized many aspects of our daily lives. It has affected the way we do business as well as the way we spend our leisure time. Count the ways you've used the Internet recently. Perhaps you've sent electronic mail (e-mail) to a business associate, paid a utility bill, read a newspaper from a distant city, or looked up a local movie schedule—all by using the Internet. Or maybe you researched a medical topic, booked a hotel reservation, chatted with a fellow Trekkie, or comparison-shopped for a car. The Internet is a communication system that has brought a wealth of information to our fingertips and organized it for our use.



## A Brief History

A network is a group of connected communicating devices such as computers and printers. An internet (note the lowercase letter i) is two or more networks that can communicate with each other. The most notable internet is called the Internet (uppercase letter I), a collaboration of more than hundreds of thousands of interconnected networks. Private individuals as well as various organizations such as government agencies, schools, research facilities, corporations, and libraries in more than 100 countries use the Internet. Millions of people are users. Yet this extraordinary communication system only came into being in 1969.

In the mid-1960s, mainframe computers in research organizations were standalone devices. Computers from different manufacturers were unable to communicate with one another. The Advanced Research Projects Agency (ARPA) in the Department of Defense (DoD) was interested in finding a way to connect computers so that the researchers they funded could share their findings, thereby reducing costs and eliminating duplication of effort.

In 1967, at an Association for Computing Machinery (ACM) meeting, ARPA presented its ideas for ARPANET, a small network of connected computers. The idea was that each host computer (not necessarily from the same manufacturer) would be attached to a specialized computer, called an *interface message processor* (IMP). The IMPs, in turn, would be connected to one another. Each IMP had to be able to communicate with other IMPs as well as with its own attached host. By 1969, ARPANET was a reality. Four nodes, at the University of California at Los Angeles (UCLA), the University of California at Santa Barbara (UCSB), Stanford Research Institute (SRI), and the University of Utah, were connected via the IMPs to form a network. Software called the *Network Control Protocol* (NCP) provided communication between the hosts.

In 1972, Vint Cerf and Bob Kahn, both of whom were part of the core ARPANET group, collaborated on what they called the *Internetworking Project*. Cerf and Kahn's landmark 1973 paper outlined the protocols to achieve end-to-end delivery of packets. This paper on Transmission Control Protocol (TCP) included concepts such as encapsulation, the datagram, and the functions of a gateway. Shortly thereafter, authorities made a decision to split TCP into two protocols: Transmission Control Protocol (TCP) and Internetworking Protocol (IP). IP would handle datagram routing while TCP would be responsible for higher-level functions such as

segmentation, reassembly, and error detection. The internetworking protocol became known as TCP/IP.

### The Internet Today

The Internet has come a long way since the 1960s. The Internet today is not a simple hierarchical structure. It is made up of many wide- and local-area networks joined by connecting devices and switching stations. It is difficult to give an accurate representation of the Internet because it is continually changing—new networks are being added, existing networks are adding addresses, and networks of defunct companies are being removed. Today most end users who want Internet connection use the services of Internet service providers (ISPs). There are international service providers, national service providers, regional service providers, and local service providers. The Internet today is run by private companies, not the government. Figure 1.13 shows a conceptual (not geographic) view of the Internet.

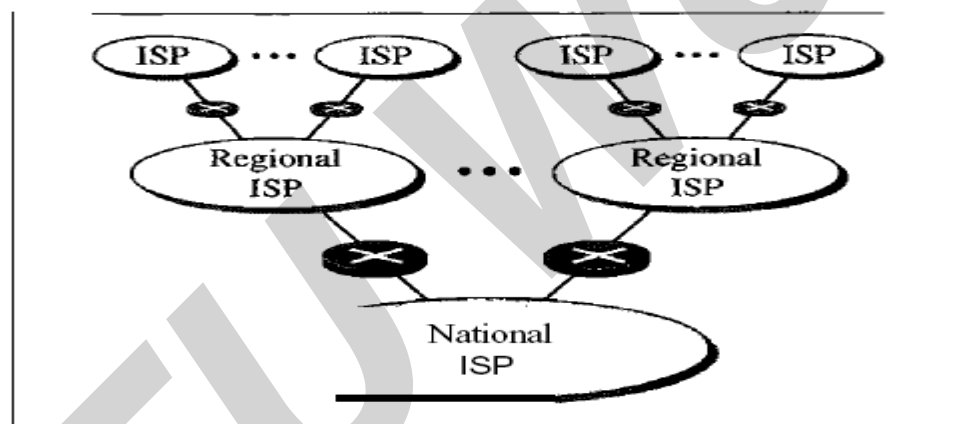

a. Structure of a national ISP

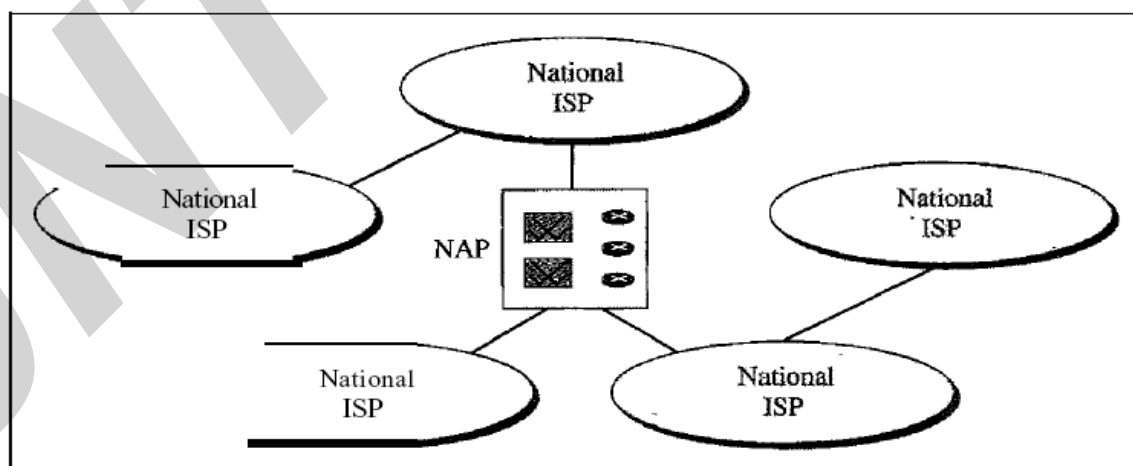

b. Interconnection of national ISPs

### *International Internet Service Providers:*

At the top of the hierarchy are the international service providers that connect nations together.

### *National Internet Service Providers:*

The national Internet service providers are backbone networks created and maintained by specialized companies. There are many national ISPs operating in North America; some of the most well known are SprintLink, PSINet, UUNet Technology, AGIS, and internet Mel. To provide connectivity between the end users, these backbone networks are connected by complex switching stations (normally run by a third party) called network access points (NAPs). Some national ISP networks are also connected to one another by private switching stations called *peering points*. These normally operate at a high data rate (up to 600 Mbps).

### *Regional Internet Service Providers:*

Regional internet service providers or regional ISPs are smaller ISPs that are connected to one or more national ISPs. They are at the third level of the hierarchy with a smaller data rate.

### *Local Internet Service Providers:*

Local Internet service providers provide direct service to the end users. The local ISPs can be connected to regional ISPs or directly to national ISPs. Most end users are connected to the local ISPs. Note that in this sense, a local ISP can be a company that just provides Internet services, a corporation with a network that supplies services to its own employees, or a nonprofit organization, such as a college or a university, that runs its own network. Each of these local ISPs can be connected to a regional or national service provider.

## **1.4 PROTOCOLS AND STANDARDS**

### **Protocols:**

In computer networks, communication occurs between entities in different systems. An entity is anything capable of sending or receiving information. However, two entities cannot simply send bit streams to each other and expect to be understood. For communication to occur, the entities must agree on a protocol. A protocol is a set of rules that govern data communications. A protocol defines what is communicated, how it is communicated, and when it is communicated. The key elements of a protocol are syntax, semantics, and timing.

o Syntax. The term *syntax* refers to the structure or format of the data, meaning the order in which they are presented. For example, a simple protocol might expect the first 8 bits of data to be the address of the sender, the second 8 bits to be the address of the receiver, and the rest of the stream to be the message itself.

o Semantics. The word *semantics* refers to the meaning of each section of bits. How is a particular pattern to be interpreted, and what action is to be taken based on that interpretation? For example, does an address identify the route to be taken or the final destination of the message?

o Timing. The term *timing* refers to two characteristics: when data should be sent and how fast they can be sent. For example, if a sender produces data at 100 Mbps but the receiver can process data at only 1 Mbps, the transmission will overload the receiver and some data will be lost.

### **Standards**

Standards are essential in creating and maintaining an open and competitive market for equipment manufacturers and in guaranteeing national and international interoperability of data and telecommunications technology and processes. Standards provide guidelines to manufacturers, vendors, government agencies, and other service providers to ensure the kind of interconnectivity necessary in today's marketplace and in international communications.

Data communication standards fall into two categories: *de facto* (meaning "by fact" or "by convention") and *de jure* (meaning "by law" or "by regulation").

o De facto. Standards that have not been approved by an organized body but have been adopted as standards through widespread use are de facto standards. De facto standards are often established originally by manufacturers who seek to define the functionality of a new product or technology.

o De jure. Those standards that have been legislated by an officially recognized body are de jure standards.

## 1.5 LAYERED TASKS

We use the concept of layers in our daily life. As an example, let us consider two friends who communicate through postal mail. The process of sending a letter to a friend would be complex if there were no services available from the post office. Below Figure shows the steps in this task.

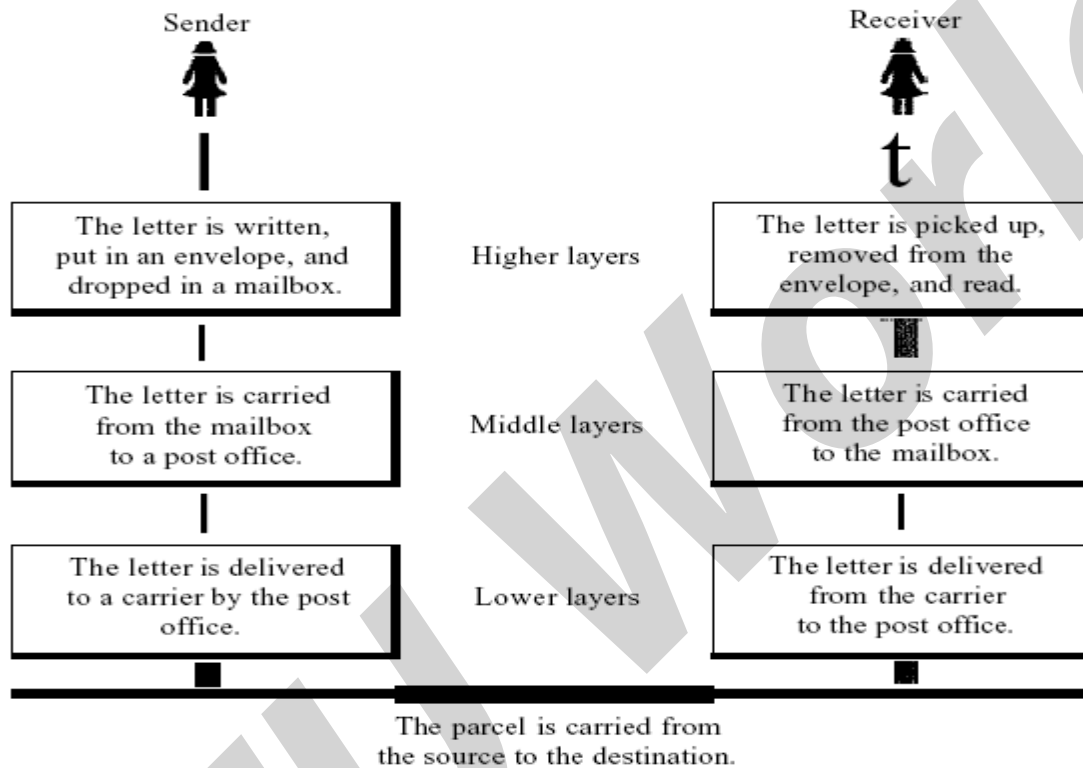

Sender, Receiver, and Carrier

In Figure we have a sender, a receiver, and a carrier that transports the letter. There is a hierarchy of tasks.

*At the Sender Site*

Let us first describe, in order, the activities that take place at the sender site.

- o Higher layer. The sender writes the letter, inserts the letter in an envelope, writes the sender and receiver addresses, and drops the letter in a mailbox.
- o Middle layer. The letter is picked up by a letter carrier and delivered to the post office.
- o Lower layer. The letter is sorted at the post office; a carrier transports the letter.

*On the Way:* The letter is then on its way to the recipient. On the way to the recipient's local post office, the letter may actually go through a central office. In addition, it may be transported by truck, train, airplane, boat, or a combination of these.

### *At the Receiver Site*

- o Lower layer. The carrier transports the letter to the post office.
- o Middle layer. The letter is sorted and delivered to the recipient's mailbox.
- o Higher layer. The receiver picks up the letter, opens the envelope, and reads it.

### **1.6 The OSI Reference Model:**

The OSI model (minus the physical medium) is shown in Fig. This model is based on a proposal developed by the International Standards Organization (ISO) as a first step toward international standardization of the protocols used in the various layers (Day and Zimmermann, 1983). It was revised in 1995 (Day, 1995). The model is called the ISO-OSI (Open Systems Interconnection) Reference Model because it deals with connecting open systems—that is, systems that are open for communication with other systems.

The OSI model has seven layers. The principles that were applied to arrive at the seven layers can be briefly summarized as follows:

1. A layer should be created where a different abstraction is needed.
2. Each layer should perform a well-defined function.
3. The function of each layer should be chosen with an eye toward defining internationally standardized protocols.
4. The layer boundaries should be chosen to minimize the information flow across the interfaces.
5. The number of layers should be large enough that distinct functions need not be thrown together in the same layer out of necessity and small enough that the architecture does not become unwieldy.

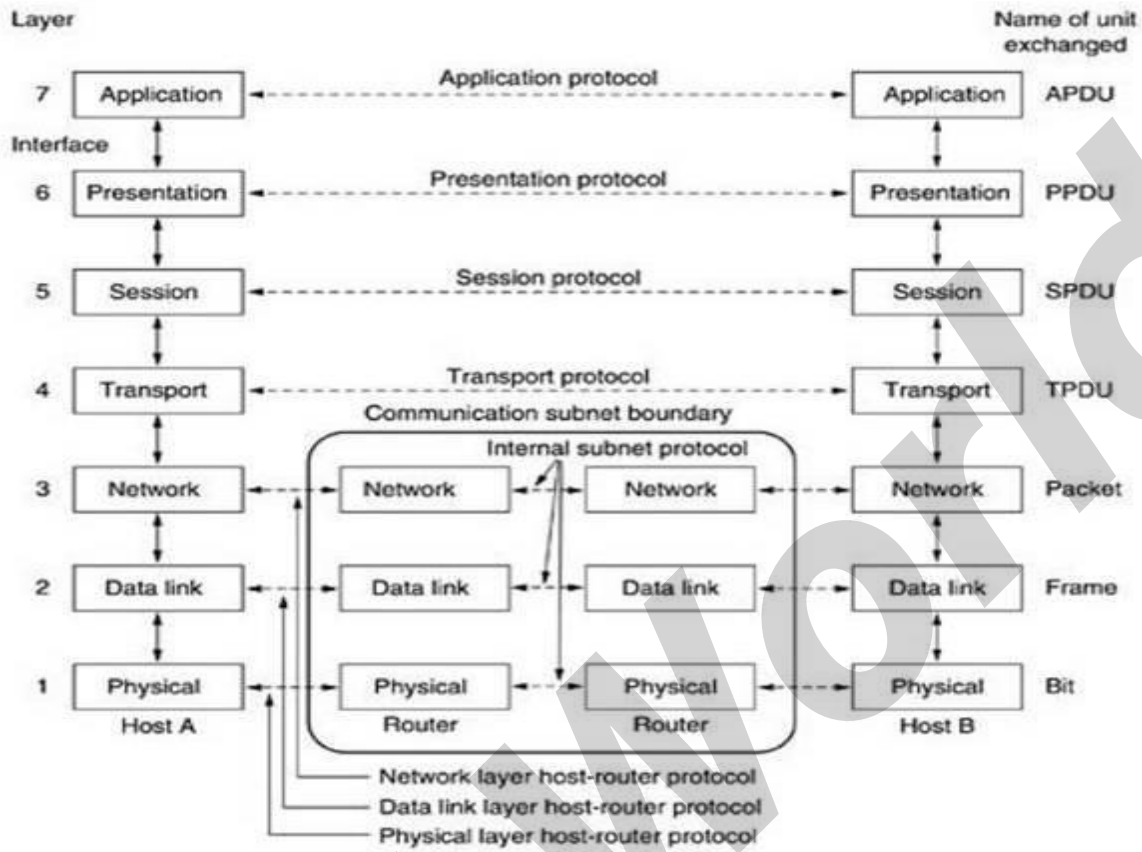

**Fig.4: The OSI reference model**

### The Physical Layer:

The physical layer is concerned with transmitting raw bits over a communication channel. The design issues have to do with making sure that when one side sends a 1 bit, it is received by the other side as a 1 bit, not as a 0 bit.

### The Data Link Layer:

The main task of the data link layer is to transform a raw transmission facility into a line that appears free of undetected transmission errors to the network layer. It accomplishes this task by having the sender break up the input data into data frames (typically a few hundred or a few thousand bytes) and transmits the frames sequentially. If the service is reliable, the receiver confirms correct receipt of each frame by sending back an acknowledgement frame.

Another issue that arises in the data link layer (and most of the higher layers as well) is how to keep a fast transmitter from drowning a slow receiver in data. Some traffic regulation mechanism is often needed to let the transmitter know how much buffer space the receiver has at the moment. Frequently, this flow regulation and the error handling are integrated.

**The Network Layer:**

The network layer controls the operation of the subnet. A key design issue is determining how packets are routed from source to destination. Routes can be based on static tables that are "wired into" the network and rarely changed. They can also be determined at the start of each conversation, for example, a terminal session (e.g., a login to a remote machine). Finally, they can be highly dynamic, being determined anew for each packet, to reflect the current network load.

If too many packets are present in the subnet at the same time, they will get in one another's way, forming bottlenecks. The control of such congestion also belongs to the network layer. More generally, the quality of service provided (delay, transit time, jitter, etc.) is also a network layer issue.

When a packet has to travel from one network to another to get to its destination, many problems can arise. The addressing used by the second network may be different from the first one. The second one may not accept the packet at all because it is too large. The protocols may differ, and so on. It is up to the network layer to overcome all these problems to allow heterogeneous networks to be interconnected. In broadcast networks, the routing problem is simple, so the network layer is often thin or even nonexistent.

**The Transport Layer:**

The basic function of the transport layer is to accept data from above, split it up into smaller units if need be, pass these to the network layer, and ensure that the pieces all arrive correctly at the other end. Furthermore, all this must be done efficiently and in a way that isolates the upper layers from the inevitable changes in the hardware technology. The transport layer also determines what type of service to provide to the session layer, and, ultimately, to the users of the network. The most popular type of transport connection is an error-free point-to-point channel that delivers messages or bytes in the order in which they were sent. However, other possible kinds of transport service are the transporting of isolated messages, with no guarantee about the order of delivery, and the broadcasting of messages to multiple destinations. The type of service is determined when the connection is established.

The transport layer is a true end-to-end layer, all the way from the source to the destination. In other words, a program on the source machine carries on a conversation with a similar program on the destination machine, using the message headers and control messages. In the lower layers,



the protocols are between each machine and its immediate neighbours, and not between the ultimate source and destination machines, which may be separated by many routers.

### **The Session Layer:**

The session layer allows users on different machines to establish sessions between them. Sessions offer various services, including dialog control (keeping track of whose turn it is to transmit), token management (preventing two parties from attempting the same critical operation at the same time), and synchronization (check pointing long transmissions to allow them to continue from where they were after a crash).

### **The Presentation Layer:**

The presentation layer is concerned with the syntax and semantics of the information transmitted. In order to make it possible for computers with different data representations to communicate, the data structures to be exchanged can be defined in an abstract way, along with a standard encoding to be used "on the wire." The presentation layer manages these abstract data structures and allows higher-level data structures (e.g., banking records), to be defined and exchanged.

### **The Application Layer:**

The application layer contains a variety of protocols that are commonly needed by users. One widely-used application protocol is HTTP (Hypertext Transfer Protocol), which is the basis for the World Wide Web. When a browser wants a Web page, it sends the name of the page it wants to the server using HTTP. The server then sends the page back. Other application protocols are used for file transfer, electronic mail, and network news.

## **1.7 The TCP/IP Reference Model:**

The TCP/IP reference model was developed prior to OSI model. The major design goals of this model were,

1. To connect multiple networks together so that they appear as a single network.
2. To survive after partial subnet hardware failures.
3. To provide a flexible architecture.

Unlike OSI reference model, TCP/IP reference model has only 4 layers. They are,

1. Host-to-Network Layer
2. Internet Layer

3. Transport Layer

4. Application Layer

Application Layer

Transport Layer

Internet Layer

Host-to-Network Layer

### **Host-to-Network Layer:**

The TCP/IP reference model does not really say much about what happens here, except to point out that the host has to connect to the network using some protocol so it can send IP packets to it. This protocol is not defined and varies from host to host and network to network.

### **Internet Layer:**

This layer, called the internet layer, is the linchpin that holds the whole architecture together. Its job is to permit hosts to inject packets into any network and have them travel independently to the destination (potentially on a different network). They may even arrive in a different order than they were sent, in which case it is the job of higher layers to rearrange them, if in-order delivery is desired. Note that "internet" is used here in a generic sense, even though this layer is present in the Internet.

The internet layer defines an official packet format and protocol called IP (Internet Protocol). The job of the internet layer is to deliver IP packets where they are supposed to go. Packet routing is clearly the major issue here, as is avoiding congestion. For these reasons, it is reasonable to say that the TCP/IP internet layer is similar in functionality to the OSI network layer. Fig. shows this correspondence.

### **The Transport Layer:**

The layer above the internet layer in the TCP/IP model is now usually called the transport layer. It is designed to allow peer entities on the source and destination hosts to carry on a conversation, just as in the OSI transport layer. Two end-to-end transport protocols have been defined here. The first one, TCP (Transmission Control Protocol), is a reliable connection-oriented protocol that allows a byte stream originating on one machine to be delivered without error on any other machine in the internet. It fragments the incoming byte stream into discrete messages and passes each one on to the internet layer. At the destination, the receiving TCP process reassembles the received messages into the output stream. TCP also handles flow control

to make sure a fast sender cannot swamp a slow receiver with more messages than it can handle.

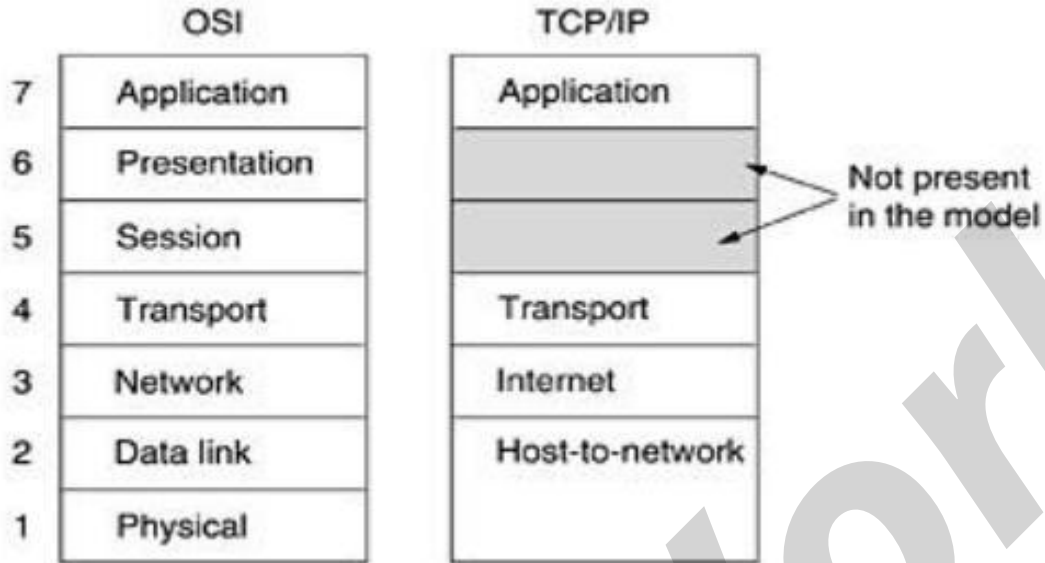

**Fig.1: The TCP/IP reference model.**

The second protocol in this layer, UDP (User Datagram Protocol), is an unreliable, connectionless protocol for applications that do not want TCP's sequencing or flow control and wish to provide their own. It is also widely used for one-shot, client-server-type request-reply queries and applications in which prompt delivery is more important than accurate delivery, such as transmitting speech or video. The relation of IP, TCP, and UDP is shown in Fig.2. Since the model was developed, IP has been implemented on many other networks.

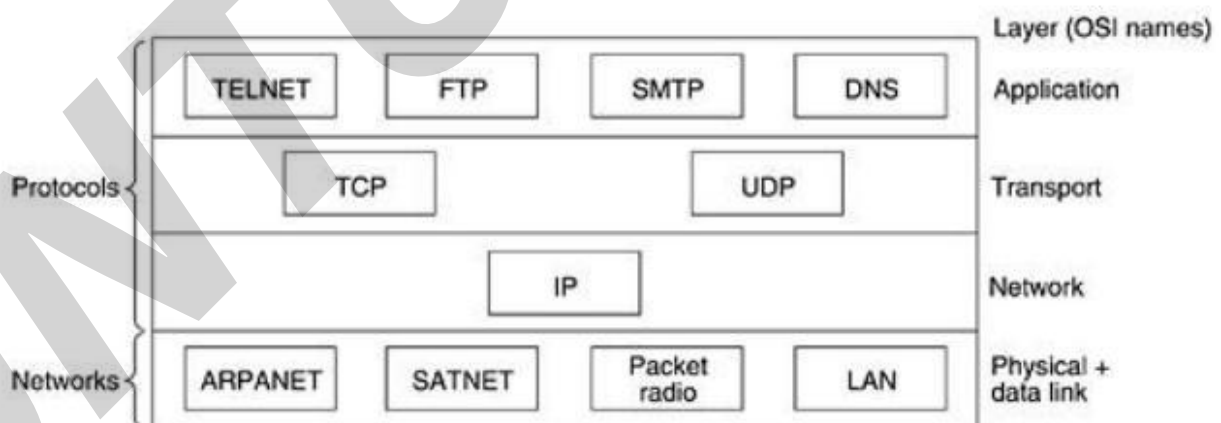

**Fig.2: Protocols and networks in the TCP/IP model initially.**

### **The Application Layer:**

The TCP/IP model does not have session or presentation layers. On top of the transport layer is the application layer. It contains all the higher-level protocols. The early ones included virtual terminal (TELNET), file transfer (FTP), and electronic mail (SMTP), as shown in Fig.6.2. The virtual terminal protocol allows a user on one machine to log onto a distant machine and work there. The file transfer protocol provides a way to move data efficiently from one machine to another. Electronic mail was originally just a kind of file transfer, but later a specialized protocol (SMTP) was developed for it. Many other protocols have been added to these over the years: the Domain Name System (DNS) for mapping host names onto their network addresses, NNTP, the protocol for moving USENET news articles around, and HTTP, the protocol for fetching pages on the World Wide Web, and many others.

### **Comparison of the OSI and TCP/IP Reference Models:**

The OSI and TCP/IP reference models have much in common. Both are based on the concept of a stack of independent protocols. Also, the functionality of the layers is roughly similar. For example, in both models the layers up through and including the transport layer are there to provide an end-to-end, network-independent transport service to processes wishing to communicate. These layers form the transport provider. Again in both models, the layers above transport are application-oriented users of the transport service. Despite these fundamental similarities, the two models also have many differences. Three concepts are central to the OSI model:

1. Services.
2. Interfaces.
3. Protocols.

Probably the biggest contribution of the OSI model is to make the distinction between these three concepts explicit. Each layer performs some services for the layer above it. The service definition tells what the layer does, not how entities above it access it or how the layer works. It defines the layer's semantics.

A layer's interface tells the processes above it how to access it. It specifies what the parameters are and what results to expect. It, too, says nothing about how the layer works inside.

Finally, the peer protocols used in a layer are the layer's own business. It can use any protocols it wants to, as long as it gets the job done (i.e., provides the offered services). It can also change them at will without affecting software in higher layers.

The TCP/IP model did not originally clearly distinguish between service, interface, and protocol, although people have tried to retrofit it after the fact to make it more OSI-like. For example, the only real services offered by the internet layer are SEND IP PACKET and RECEIVE IP PACKET.

As a consequence, the protocols in the OSI model are better hidden than in the TCP/IP model and can be replaced relatively easily as the technology changes. Being able to make such changes is one of the main purposes of having layered protocols in the first place. The OSI reference model was devised before the corresponding protocols were invented. This ordering means that the model was not biased toward one particular set of protocols, a fact that made it quite general. The downside of this ordering is that the designers did not have much experience with the subject and did not have a good idea of which functionality to put in which layer.

Another difference is in the area of connectionless versus connection-oriented communication. The OSI model supports both connectionless and connection-oriented communication in the network layer, but only connection-oriented communication in the transport layer, where it counts (because the transport service is visible to the users). The TCP/IP model has only one mode in the network layer (connectionless) but supports both modes in the transport layer, giving the users a choice. This choice is especially important for simple request-response protocols.

## UNIT- 2

### Physical Layer and Overview of PL Switching

#### 2.1 MULTIPLEXING

Multiplexing is the set of techniques that allows the simultaneous transmission of multiple signals across a single data link.

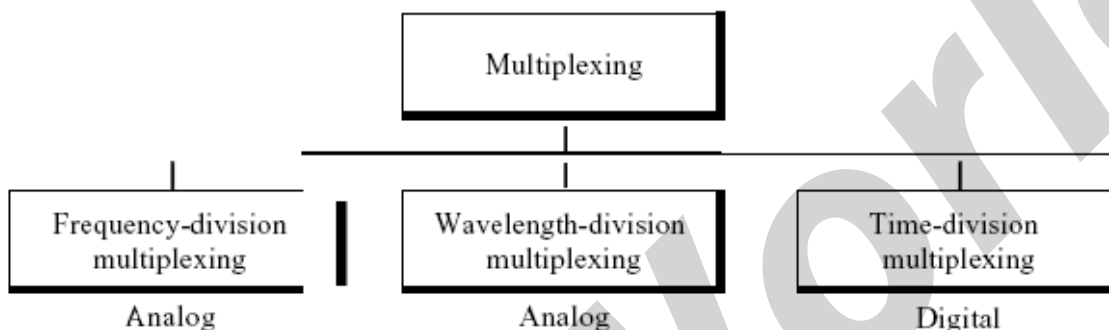

Figure Categories of multiplexing

#### 2.1.1 Frequency-Division Multiplexing

Frequency-division multiplexing (FDM) is an analog technique that can be applied when the bandwidth of a link (in hertz) is greater than the combined bandwidths of the signals to be transmitted. In FDM, signals generated by each sending device modulate different carrier frequencies. These modulated signals are then combined into a single composite signal that can be transported by the link. Carrier frequencies are separated by sufficient bandwidth to accommodate the modulated signal. These bandwidth ranges are the channels through which the various signals travel. Channels can be separated by strips of unused bandwidth-guard bands-to prevent signals from overlapping. In addition, carrier frequencies must not interfere with the original data frequencies.

Figure 1 gives a conceptual view of FDM. In this illustration, the transmission path is divided into three parts, each representing a channel that carries one transmission.

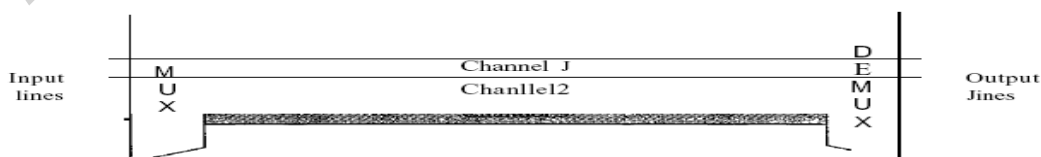

Fig: FDM

We consider FDM to be an analog multiplexing technique; however, this does not mean that FDM cannot be used to combine sources sending digital signals. A digital signal can be converted to an analog signal before FDM is used to multiplex them.

### Multiplexing Process

Figure 2 is a conceptual illustration of the multiplexing process. Each source generates a signal of a similar frequency range. Inside the multiplexer, these similar signals modulates different carrier frequencies ( $f_1, f_2$ , and  $f_3$ ). The resulting modulated signals are then combined into a single composite signal that is sent out over a media link that has enough bandwidth to accommodate it.

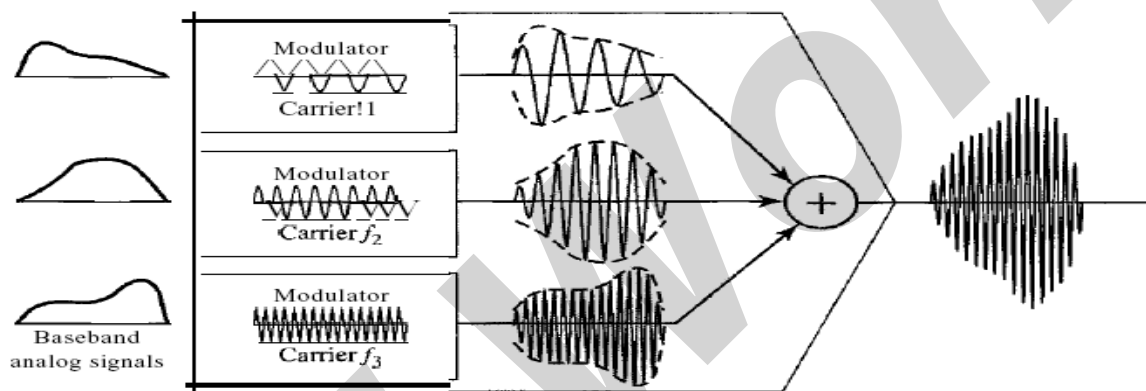

Figure 2 FDM process

### Demultiplexing Process

The demultiplexer uses a series of filters to decompose the multiplexed signal into its constituent component signals. The individual signals are then passed to a demodulator that separates them from their carriers and passes them to the output lines. Figure 3 is a conceptual illustration of demultiplexing process.

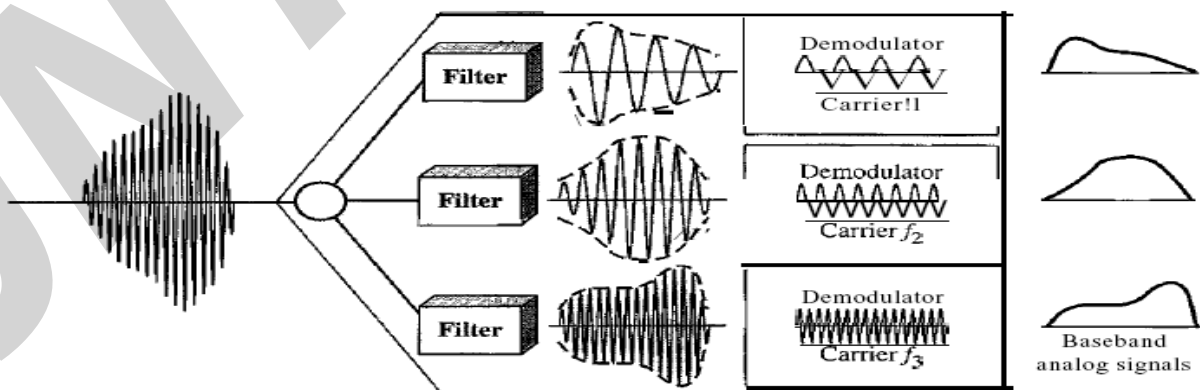

Figure 3 FDM de-multiplexing example

### 2.1.2 Wavelength-Division Multiplexing

Wavelength-division multiplexing (WDM) is designed to use the high-data-rate capability of fiber-optic cable. The optical fiber data rate is higher than the data rate of metallic transmission cable. Using a fiber-optic cable for one single line wastes the available bandwidth. Multiplexing allows us to combine several lines into one.

WDM is conceptually the same as FDM, except that the multiplexing and demultiplexing involve optical signals transmitted through fiber-optic channels. The idea is the same: We are combining different signals of different frequencies. The difference is that the frequencies are very high.

Figure 4 gives a conceptual view of a WDM multiplexer and demultiplexer. Very narrow bands of light from different sources are combined to make a wider band of light. At the receiver, the signals are separated by the demultiplexer.

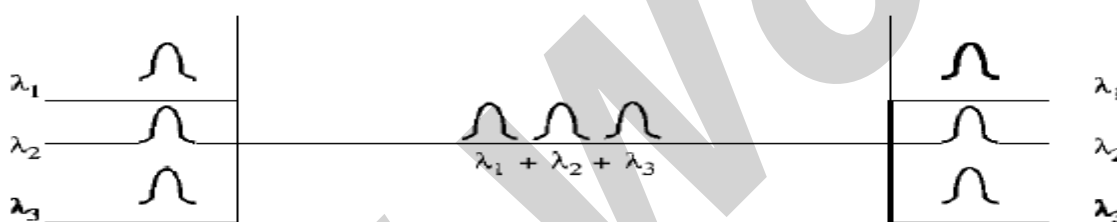

Figure 4 Wavelength-division multiplexing

Although WDM technology is very complex, the basic idea is very simple. We want to combine multiple light sources into one single light at the multiplexer and do the reverse at the demultiplexer. The combining and splitting of light sources are easily handled by a prism. Recall from basic physics that a prism bends a beam of light based on the angle of incidence and the frequency. Using this technique, a multiplexer can be made to combine several input beams of light, each containing a narrow band of frequencies, into one output beam of a wider band of frequencies. A demultiplexer can also be made to reverse the process. Figure 5 shows the concept.

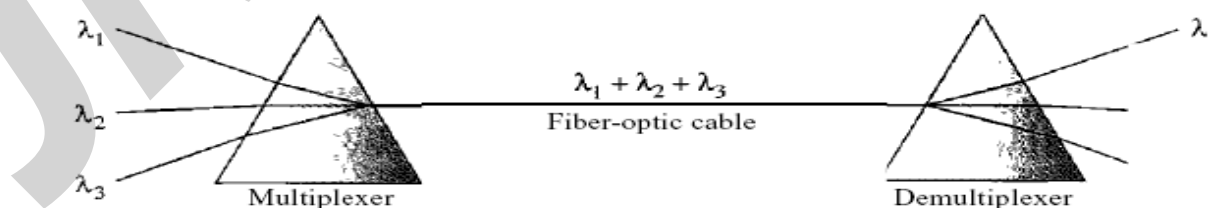

Figure 5 Prisms in wavelength-division multiplexing and demultiplexing



### 2.1.3 Synchronous Time-Division Multiplexing

Time-division multiplexing (TDM) is a digital process that allows several connections to share the high bandwidth of a line. Instead of sharing a portion of the bandwidth as in FDM, time is shared. Each connection occupies a portion of time in the link. Figure 6 gives a conceptual view of TDM. Note that the same link is used as in FDM; here, however, the link is shown sectioned by time rather than by frequency. In the figure, portions of signals 1, 2, 3, and 4 occupy the link sequentially.

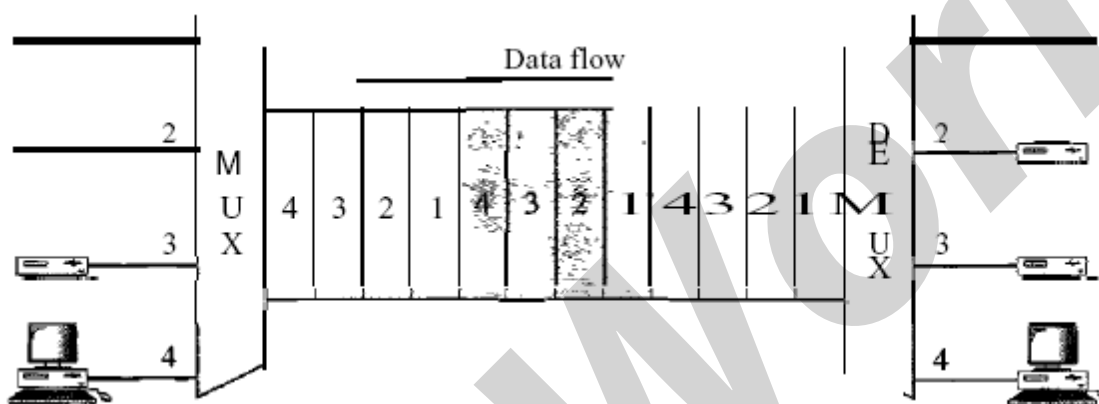

Figure 6 TDM

Note that in Figure 6 we are concerned with only multiplexing, not switching. This means that all the data in a message from source 1 always go to one specific destination, be it 1, 2, 3, or 4. The delivery is fixed and unvarying, unlike switching. We also need to remember that TDM is, in principle, a digital multiplexing technique. Digital data from different sources are combined into one timeshared link. However, this does not mean that the sources cannot produce analog data; analog data can be sampled, changed to digital data, and then multiplexed by using TDM.

We can divide TDM into two different schemes: synchronous and statistical.

In synchronous TDM, each input connection has an allotment in the output even if it is not sending data.

#### *Time Slots and Frames*

In synchronous TDM, the data flow of each input connection is divided into units, where each input occupies one input time slot. A unit can be 1 bit, one character, or one block of data. Each input unit becomes one output unit and occupies one output time slot. However, the duration of an output time slot is  $n$  times shorter than the duration of an input time slot. If an input time slot is  $T$  s, the output time slot is  $T/n$  s, where  $n$  is the number of connections. In other words, a unit

in the output connection has a shorter duration; it travels faster. Figure 7 shows an example of synchronous TDM where  $n$  is 3.

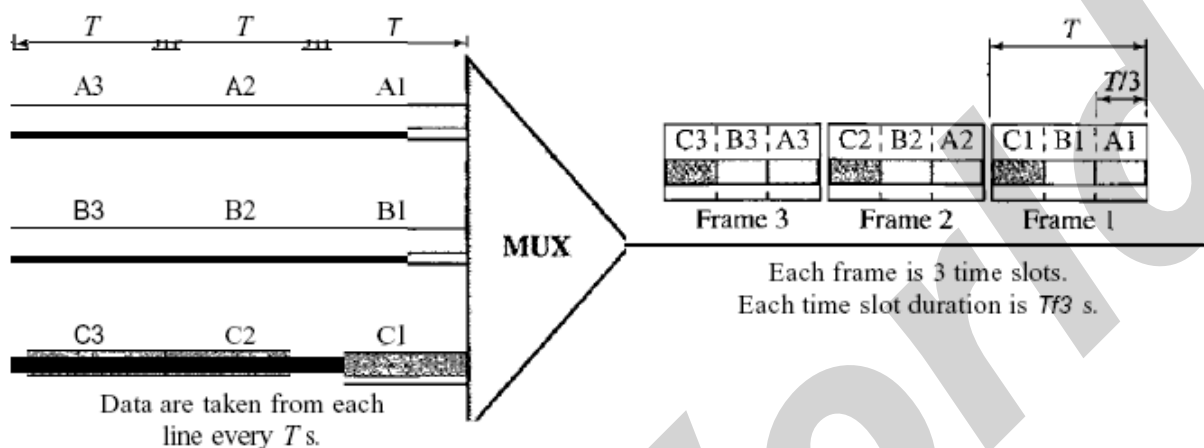

Figure 7 Synchronous time-division multiplexing

In synchronous TDM, a round of data units from each input connection is collected into a frame (we will see the reason for this shortly). If we have  $n$  connections, a frame is divided into  $n$  time slots and one slot is allocated for each unit, one for each input line. If the duration of the input unit is  $T$ , the duration of each slot is  $T/n$  and the duration of each frame is  $T$  (unless a frame carries some other information, as we will see shortly).

The data rate of the output link must be  $n$  times the data rate of a connection to guarantee the flow of data. In Figure 7, the data rate of the link is 3 times the data rate of a connection; likewise, the duration of a unit on a connection is 3 times that of the time slot (duration of a unit on the link). In the figure we represent the data prior to multiplexing as 3 times the size of the data after multiplexing. This is just to convey the idea that each unit is 3 times longer in duration before multiplexing than after. Time slots are grouped into frames. A frame consists of one complete cycle of time slots, with one slot dedicated to each sending device. In a system with  $n$  input lines, each frame has  $n$  slots, with each slot allocated to carrying data from a specific input line.

### Interleaving

TDM can be visualized as two fast-rotating switches, one on the multiplexing side and the other on the demultiplexing side. The switches are synchronized and rotate at the same speed, but in opposite directions. On the multiplexing side, as the switch opens in front of a connection, that

connection has the opportunity to send a unit onto the path. This process is called **interleaving**. On the demultiplexing side, as the switch opens in front of a connection, that connection has the opportunity to receive a unit from the path.

Figure 8 shows the interleaving process for the connection shown in Figure 7.

In this figure, we assume that no switching is involved and that the data from the first connection at the multiplexer site go to the first connection at the demultiplexer

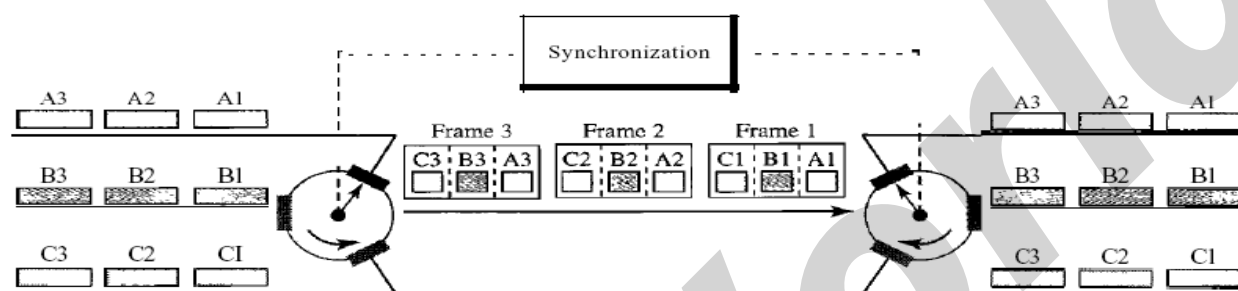

**Figure 8** *Interleaving*

- *Empty Slots*
- *Data Rate Management*
  - **Multilevel Multiplexing**
  - **Multiple-Slot Allocation**
  - **Pulse Stuffing**
- *Frame Synchronizing*
- *Digital Signal Service*

## 2.1.4 Statistical Time-Division Multiplexing

### *Addressing*

Figure a also shows a major difference between slots in synchronous TDM and statistical TDM. An output slot in synchronous TDM is totally occupied by data; in statistical TDM, a slot needs to carry data as well as the address of the destination.

In synchronous TDM, there is no need for addressing; synchronization and preassigned relationships between the inputs and outputs serve as an address. We know, for example, that input 1 always goes to input 2. If the multiplexer and the demultiplexer are synchronized, this is guaranteed. In statistical multiplexing, there is no fixed relationship between the inputs and outputs because there are no preassigned or reserved slots. We need to include the address of the

receiver inside each slot to show where it is to be delivered. The addressing in its simplest form can be  $n$  bits to define  $N$  different output lines with  $n = \log_2 N$ . For example, for eight different output lines, we need a 3-bit address.

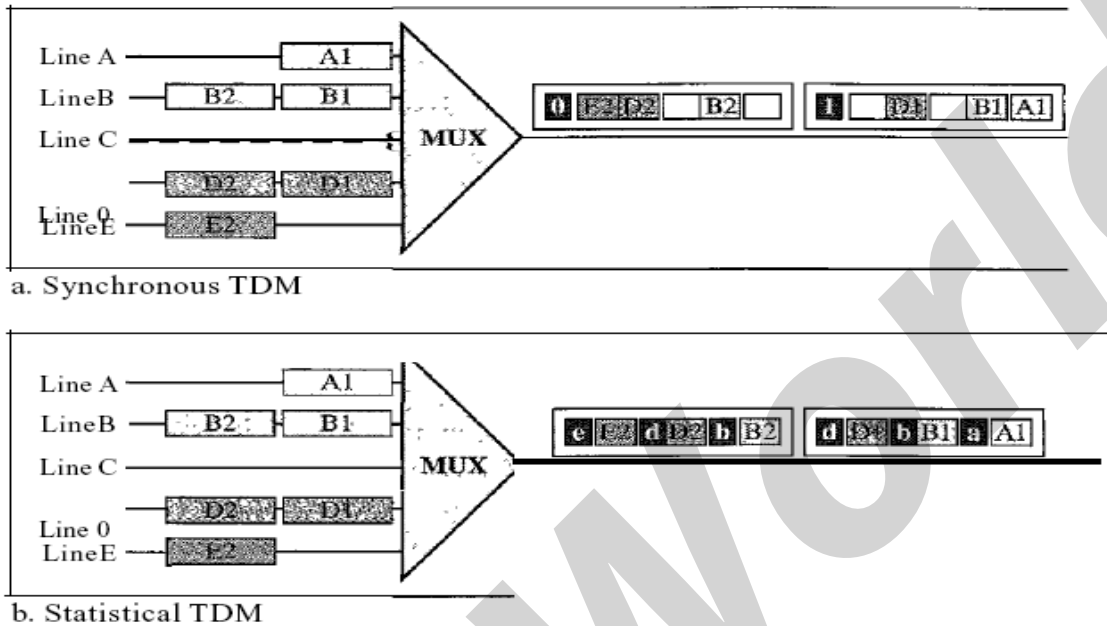

Figure a TDM slot comparison

### Slot Size

Since a slot carries both data and an address in statistical TDM, the ratio of the data size to address size must be reasonable to make transmission efficient. For example, it would be inefficient to send 1 bit per slot as data when the address is 3 bits. This would mean an overhead of 300 percent. In statistical TDM, a block of data is usually many bytes while the address is just a few bytes.

### No Synchronization Bit

There is another difference between synchronous and statistical TDM, but this time it is at the frame level. The frames in statistical TDM need not be synchronized, so we do not need synchronization bits.

### Bandwidth

In statistical TDM, the capacity of the link is normally less than the sum of the capacities of each channel. The designers of statistical TDM define the capacity of the link based on the statistics of the load for each channel. If on average only  $x$  percent of the input slots are filled, the capacity of the link reflects this. Of course, during peak times, some slots need to wait.

## 2.2 Switching

A network is a set of connected devices. Whenever we have multiple devices, we have the problem of how to connect them to make one-to-one communication possible. One solution is to make a point-to-point connection between each pair of devices (a mesh topology) or between a central device and every other device (a star topology). These methods, however, are impractical and wasteful when applied to very large networks. The number and length of the links require too much infrastructure to be cost-efficient, and the majority of those links would be idle most of the time. Other topologies employing multipoint connections, such as a bus, are ruled out because the distances between devices and the total number of devices increase beyond the capacities of the media and equipment.

A better solution is switching. A switched network consists of a series of interlinked nodes, called switches. Switches are devices capable of creating temporary connections between two or more devices linked to the switch. In a switched network, some of these nodes are connected to the end systems (computers or telephones, for example). Others are used only for routing. Figure shows a switched network.

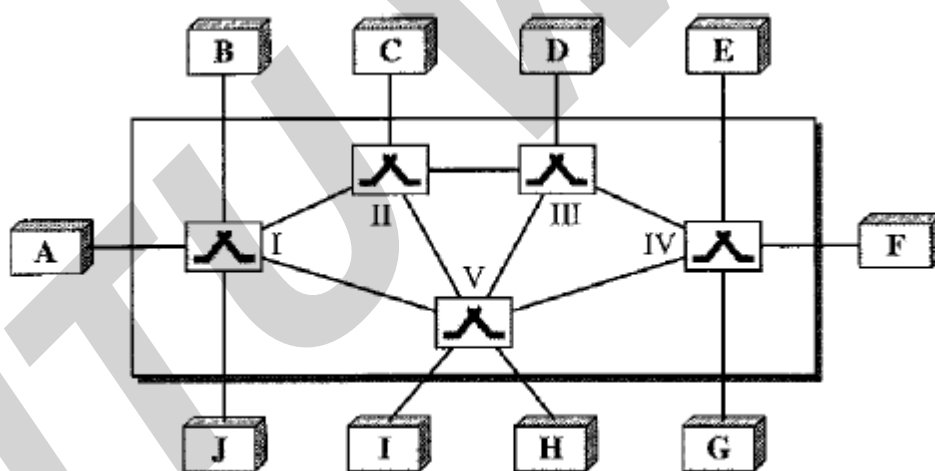

The end systems (communicating devices) are labeled A, B, C, D, and so on, and the switches are labeled I, II, III, IV, and V. Each switch is connected to multiple links.

### Taxonomy of switched networks

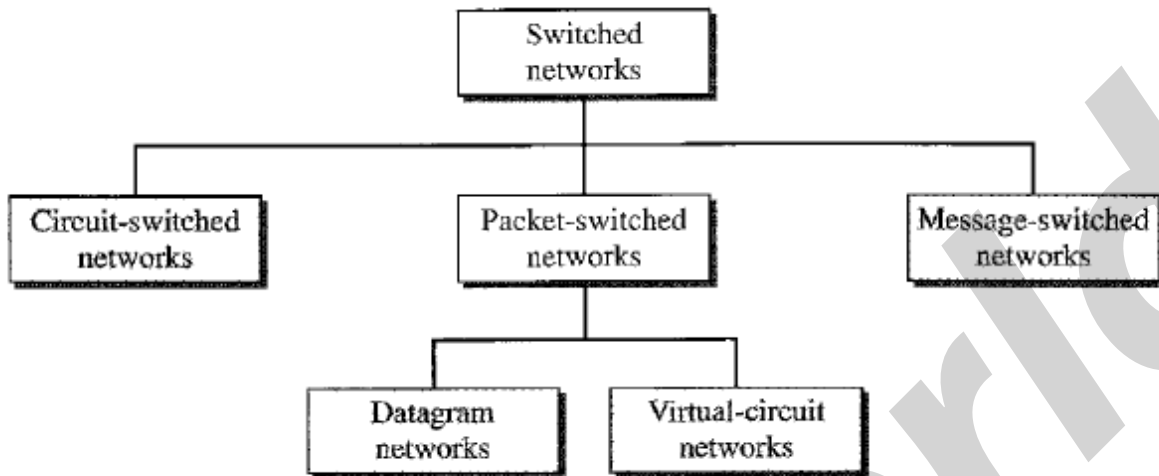

#### 2.2.1 CIRCUIT-SWITCHED NETWORKS

A circuit-switched network consists of a set of switches connected by physical links. A connection between two stations is a dedicated path made of one or more links. However, each connection uses only one dedicated channel on each link. Each link is normally divided into  $n$  channels by using FDM or TDM

Figure shows a trivial circuit-switched network with four switches and four links. Each link is divided into  $n$  ( $n$  is 3 in the figure) channels by using FDM or TDM.

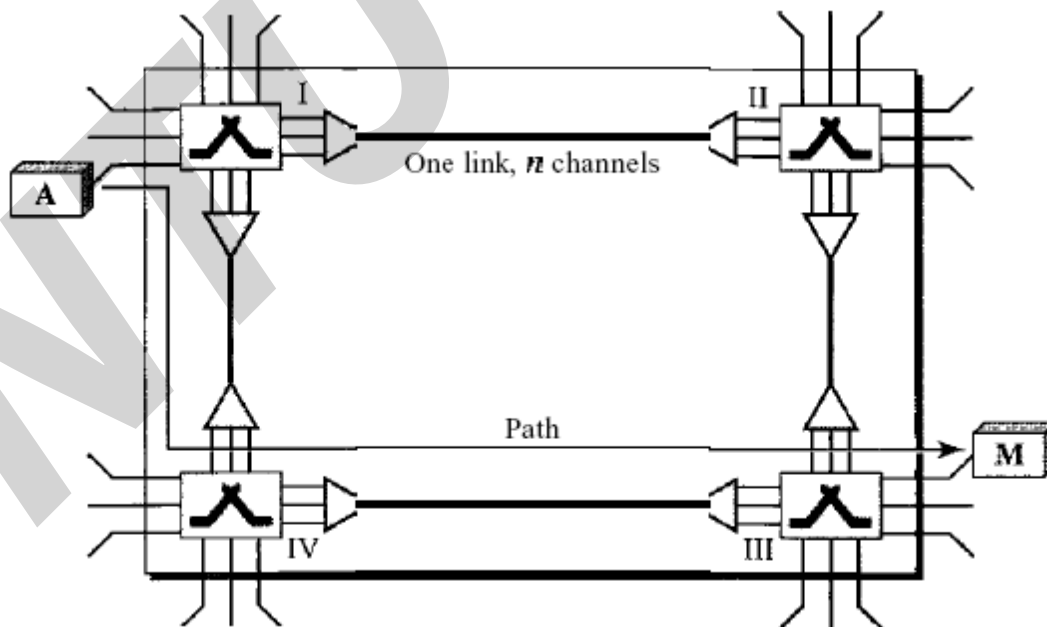

Fig: A trivial circuit-switched network

### Three Phases

The actual communication in a circuit-switched network requires three phases: connection setup, data transfer, and connection teardown.

#### ***Setup Phase:***

Before the two parties (or multiple parties in a conference call) can communicate, a dedicated circuit (combination of channels in links) needs to be established. The end systems are normally connected through dedicated lines to the switches, so connection setup means creating dedicated channels between the switches. For example, in Figure, when system A needs to connect to system M, it sends a setup request that includes the address of system M, to switch I. Switch I finds a channel between itself and switch IV that can be dedicated for this purpose. Switch I then sends the request to switch IV, which finds a dedicated channel between itself and switch III. Switch III informs system M of system A's intention at this time.

In the next step to making a connection, an acknowledgment from system M needs to be sent in the opposite direction to system A. Only after system A receives this acknowledgment is the connection established. Note that end-to-end addressing is required for creating a connection between the two end systems. These can be, for example, the addresses of the computers assigned by the administrator in a TDM network, or telephone numbers in an FDM network.

#### ***Data Transfer Phase:***

After the establishment of the dedicated circuit (channels), the two parties can transfer data.

#### ***Teardown Phase:***

When one of the parties needs to disconnect, a signal is sent to each switch to release the resources.

#### **Efficiency:**

It can be argued that circuit-switched networks are not as efficient as the other two types of networks because resources are allocated during the entire duration of the connection. These resources are unavailable to other connections. In a telephone network, people normally terminate the communication when they have finished their conversation. However, in computer networks, a computer can be connected to another computer even if there is no activity for a long time. In this case, allowing resources to be dedicated means that other connections are deprived.

## Delay

Although a circuit-switched network normally has low efficiency, the delay in this type of network is minimal. During data transfer the data are not delayed at each switch; the resources are allocated for the duration of the connection. Figure 8.6 shows the idea of delay in a circuit-switched network when only two switches are involved. As Figure shows, there is no waiting time at each switch. The total delay is due to the time needed to create the connection, transfer data, and disconnect the circuit.

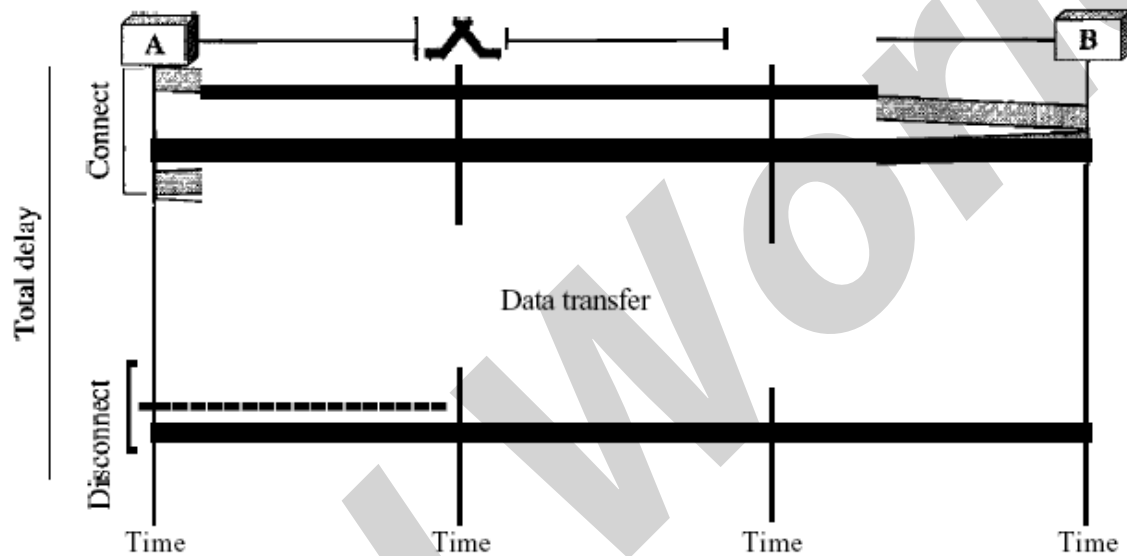

*Fig: Delay in a circuit-switched network*

The delay caused by the setup is the sum of four parts: the propagation time of the source computer request (slope of the first gray box), the request signal transfer time (height of the first gray box), the propagation time of the acknowledgment from the destination computer (slope of the second gray box), and the signal transfer time of the acknowledgment (height of the second gray box). The delay due to data transfer is the sum of two parts: the propagation time (slope of the colored box) and data transfer time (height of the colored box), which can be very long. The third box shows the time needed to tear down the circuit. We have shown the case in which the receiver requests disconnection, which creates the maximum delay.



## 2.2.2 DATAGRAM NETWORKS

In a datagram network, each packet is treated independently of all others. Even if a packet is part of a multipacket transmission, the network treats it as though it existed alone. Packets in this approach are referred to as datagrams.

Datagram switching is normally done at the network layer. We briefly discuss datagram networks here as a comparison with circuit-switched and virtual-circuit switched networks

Figure shows how the datagram approach is used to deliver four packets from station A to station X. The switches in a datagram network are traditionally referred to as routers. That is why we use a different symbol for the switches in the figure.

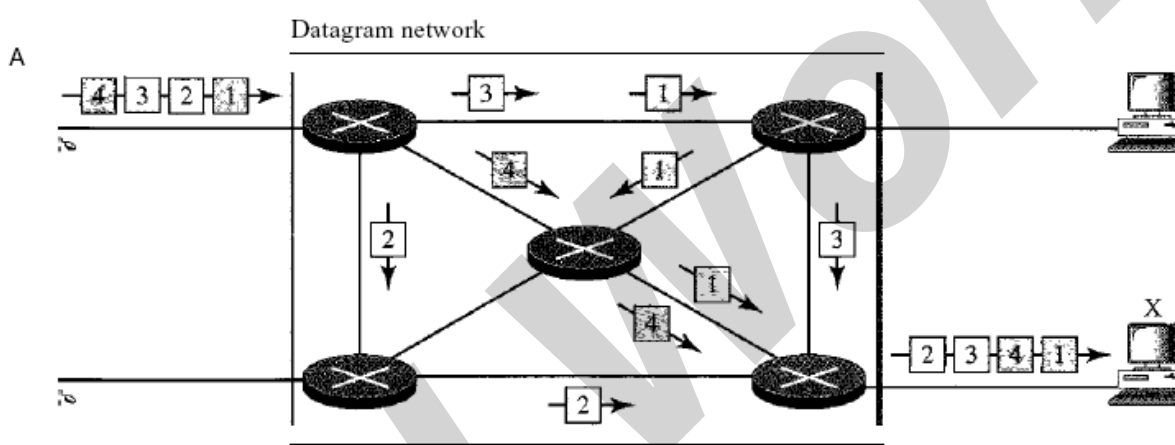

Fig: A datagram network with four switches (routers)

In this example, all four packets (or datagrams) belong to the same message, but may travel different paths to reach their destination. This is so because the links may be involved in carrying packets from other sources and do not have the necessary bandwidth available to carry all the packets from A to X. This approach can cause the datagrams of a transmission to arrive at their destination out of order with different delays between the packets. Packets may also be lost or dropped because of a lack of resources. In most protocols, it is the responsibility of an upper-layer protocol to reorder the datagrams or ask for lost datagrams before passing them on to the application.

The datagram networks are sometimes referred to as connectionless networks. The term *connectionless* here means that the switch (packet switch) does not keep information about the connection state. There are no setup or teardown phases. Each packet is treated the same by a switch regardless of its source or destination.

## Routing Table

If there are no setup or teardown phases, how are the packets routed to their destinations in a datagram network? In this type of network, each switch (or packet switch) has a routing table which is based on the destination address. The routing tables are dynamic and are updated periodically. The destination addresses and the corresponding forwarding output ports are recorded in the tables. This is different from the table of a circuit switched network in which each entry is created when the setup phase is completed and deleted when the teardown phase is over. Figure shows the routing table for a switch.

Destination address	Output port
1232	1
4150	2
.	.
9130	3

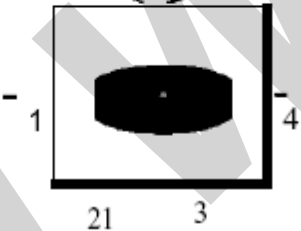

*Fig: Routing table in a datagram network*

## Destination Address

Every packet in a datagram network carries a header that contains, among other information, the destination address of the packet. When the switch receives the packet, this destination address is examined; the routing table is consulted to find the corresponding port through which the packet should be forwarded. This address, unlike the address in a virtual-circuit-switched network, remains the same during the entire journey of the packet.

## Efficiency

The efficiency of a datagram network is better than that of a circuit-switched network; resources are allocated only when there are packets to be transferred. If a source sends a packet and there is a delay of a few minutes before another packet can be sent, the resources can be reallocated during these minutes for other packets from other sources.

## Delay

There may be greater delay in a datagram network than in a virtual-circuit network. Although there are no setup and teardown phases, each packet may experience a wait at a switch before it is forwarded. In addition, since not all packets in a message necessarily travel through the same switches, the delay is not uniform for the packets of a message.

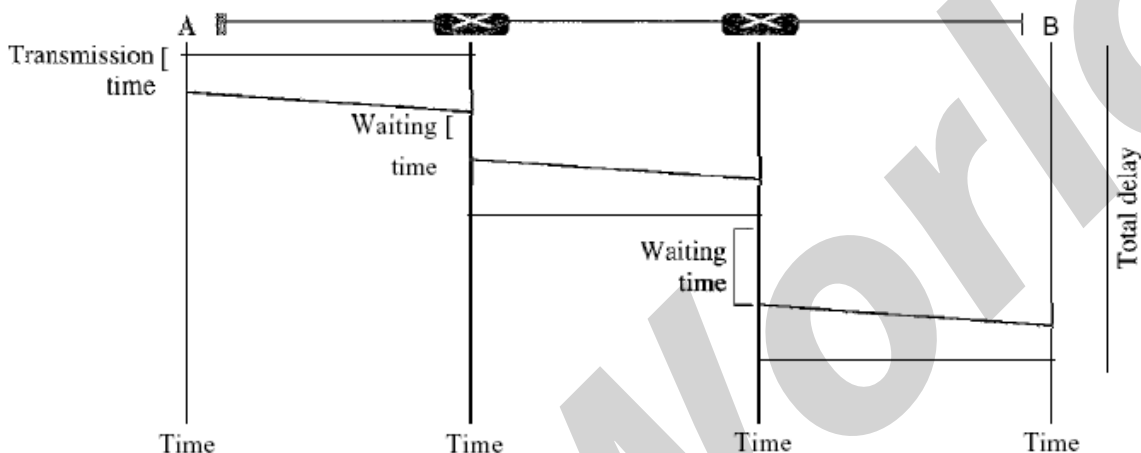

*Fig: Delay in a datagram network*

The packet travels through two switches. There are three transmission times ( $3T$ ), three propagation delays (slopes  $3t$  of the lines), and two waiting times ( $W_1 + W_2$ ). We ignore the processing time in each switch. The total delay is

$$\text{Total delay} = 3T + 3t + W_1 + W_2$$

### 2.2.3 VIRTUAL-CIRCUIT NETWORKS:

A virtual-circuit network is a cross between a circuit-switched network and a datagram network. It has some characteristics of both.

1. As in a circuit-switched network, there are setup and teardown phases in addition to the data transfer phase.
2. Resources can be allocated during the setup phase, as in a circuit-switched network, or on demand, as in a datagram network.
3. As in a datagram network, data are packetized and each packet carries an address in the header. However, the address in the header has local jurisdiction (it defines what should be the next switch and the channel on which the packet is being carried), not end-to-end jurisdiction. The reader may ask how the intermediate switches know where to send the packet if there is no

final destination address carried by a packet. The answer will be clear when we discuss virtual-circuit identifiers in the next section.

4. As in a circuit-switched network, all packets follow the same path established during the connection.

5. A virtual-circuit network is normally implemented in the data link layer, while a circuit-switched network is implemented in the physical layer and a datagram network in the network layer. But this may change in the future. Figure is an example of a virtual-circuit network. The network has switches that allow traffic from sources to destinations. A source or destination can be a computer, packet switch, bridge, or any other device that connects other networks.

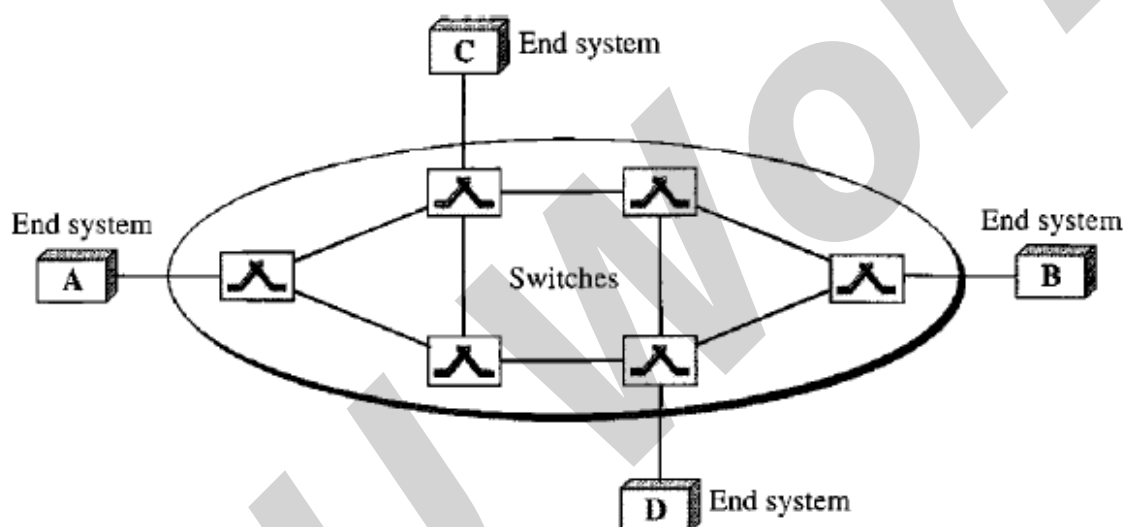

Fig a: *Virtual-circuit network*

### Addressing

In a virtual-circuit network, two types of addressing are involved: global and local (virtual-circuit identifier).

*Global Addressing:* A source or a destination needs to have a global address—an address that can be unique in the scope of the network or internationally if the network is part of an international network. However, we will see that a global address in virtual-circuit networks is used only to create a virtual-circuit identifier, as discussed next.

*Virtual-Circuit Identifier:* The identifier that is actually used for data transfer is called the virtual-circuit identifier (VCI). A VCI, unlike a global address, is a small number that has only switch scope; it is used by a frame between two switches. When a frame arrives at a switch, it has a VCI; when it leaves, it has a different VCI. Figure 8.11 shows how the VCI in a data frame

changes from one switch to another. Note that a VCI does not need to be a large number since each switch can use its own unique set of VCIs.

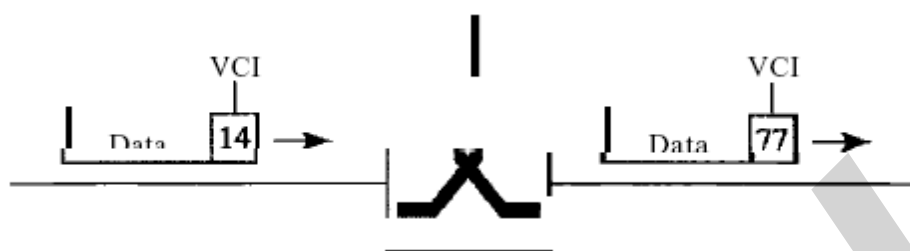

Figure 1 *Virtual-circuit identifier*

### Three Phases

As in a circuit-switched network, a source and destination need to go through three phases in a virtual-circuit network: setup, data transfer, and teardown. In the setup phase, the source and destination use their global addresses to help switches make table entries for the connection. In the teardown phase, the source and destination inform the switches to delete the corresponding entry. Data transfer occurs between these two phases. We first discuss the data transfer phase, which is more straightforward; we then talk about the setup and teardown phases.

#### *Data Transfer Phase*

To transfer a frame from a source to its destination, all switches need to have a table entry for this virtual circuit. The table, in its simplest form, has four columns. This means that the switch holds four pieces of information for each virtual circuit that is already set up. We show later how the switches make table entries, but for the moment we assume that each switch has a table with entries for all active virtual circuits. Figure 2 shows such a switch and its corresponding table. And also shows a frame arriving at port 1 with a VCI of 14. When the frame arrives, the switch looks in its table to find port 1 and a VCI of 14. When it is found, the switch knows to change the VCI to 22 and send out the frame from port 3. Figure 3 shows how a frame from source A reaches destination B and how its VCI changes during the trip. Each switch changes the VCI and routes the frame. The data transfer phase is active until the source sends all its frames to the destination. The procedure at the switch is the same for each frame of a message. The process creates a virtual circuit, not a real circuit, between the source and destination.

#### *Setup Phase*

In the setup phase, a switch creates an entry for a virtual circuit. For example, suppose source A needs to create a virtual circuit to B. Two steps are required: the setup request and the acknowledgment.

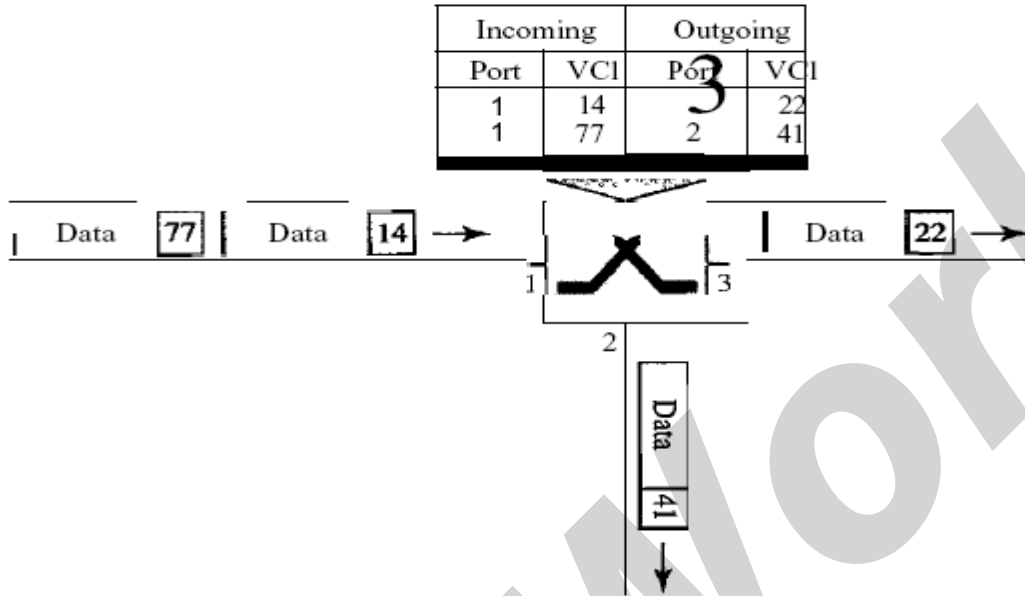

Figure 2 Switch and tables in a virtual-circuit network

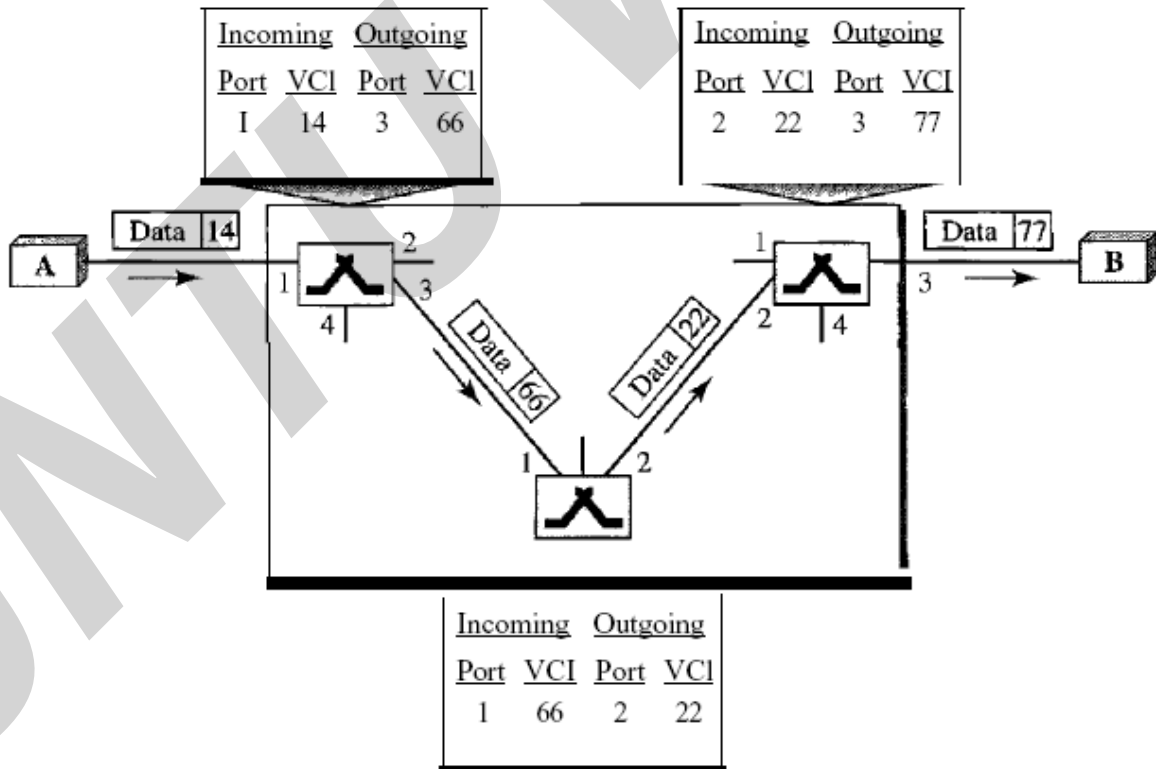
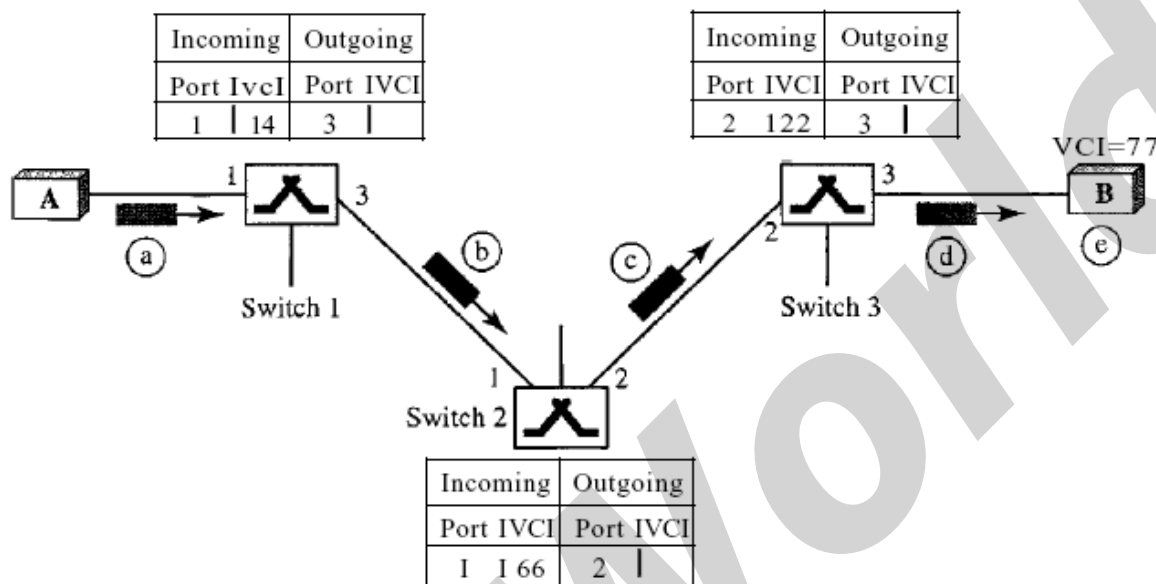

Figure 3 Source-to-destination data transfer in a virtual-circuit network

## Setup Request

A setup request frame is sent from the source to the destination.

Figure 4 shows the process.



**Figure 4** Setup request in a virtual-circuit network

a. Source A sends a setup frame to switch 1.

b. Switch 1 receives the setup request frame. It knows that a frame going from A to B goes out through port 3. How the switch has obtained this information is a point covered in future chapters. The switch, in the setup phase, acts as a packet switch; it has a routing table which is different from the switching table. For the moment, assume that it knows the output port. The switch creates an entry in its table for this virtual circuit, but it is only able to fill three of the four columns. The switch assigns the incoming port (1) and chooses an available incoming VCI (14) and the outgoing port (3). It does not yet know the outgoing VCI, which will be found during the acknowledgment step. The switch then forwards the frame through port 3 to switch 2.

c. Switch 2 receives the setup request frame. The same events happen here as at switch 1; three columns of the table are completed: in this case, incoming port (1), incoming VCI (66), and outgoing port (2).

d. Switch 3 receives the setup request frame. Again, three columns are completed: incoming port (2), incoming VCI (22), and outgoing port (3).

e. Destination B receives the setup frame, and if it is ready to receive frames from A, it assigns a VCI to the incoming frames that come from A, in this case 77. This VCI lets the destination know that the frames come from A, and not other sources.

**Acknowledgment** A special frame, called the acknowledgment frame, completes the entries in the switching tables. Figure 8.15 shows the process.

- The destination sends an acknowledgment to switch 3. The acknowledgment carries the global source and destination addresses so the switch knows which entry in the table is to be completed. The frame also carries VCI 77, chosen by the destination as the incoming VCI for frames from A. Switch 3 uses this VCI to complete the outgoing VCI column for this entry. Note that 77 is the incoming VCI for destination B, but the outgoing VCI for switch 3.
- Switch 3 sends an acknowledgment to switch 2 that contains its incoming VCI in the table, chosen in the previous step. Switch 2 uses this as the outgoing VCI in the table.
- Switch 2 sends an acknowledgment to switch 1 that contains its incoming VCI in the table, chosen in the previous step. Switch 1 uses this as the outgoing VCI in the table.
- Finally switch 1 sends an acknowledgment to source A that contains its incoming VCI in the table, chosen in the previous step.
- The source uses this as the outgoing VCI for the data frames to be sent to destination B.

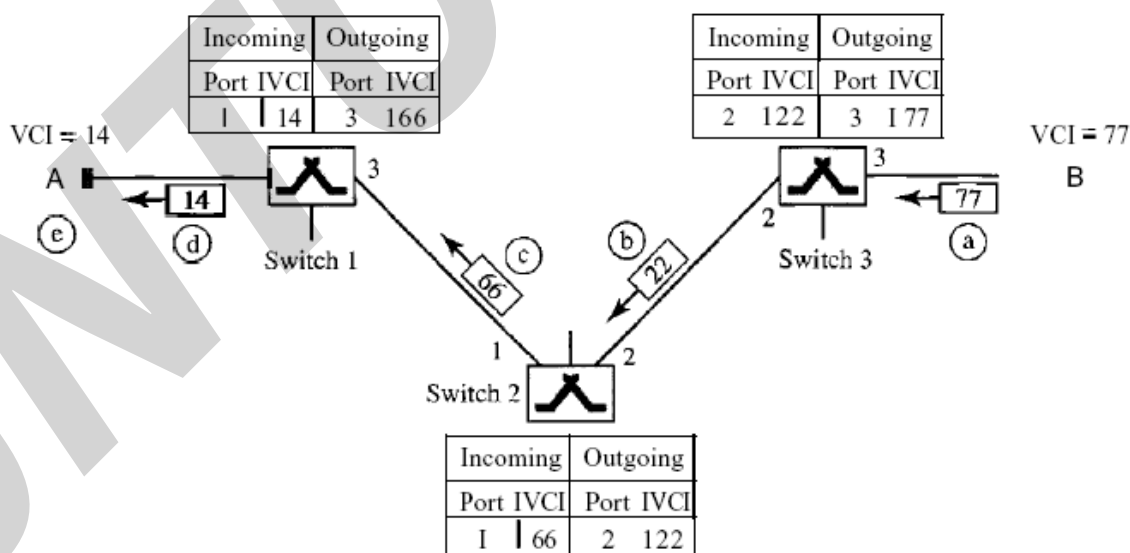

Figure 5 Setup acknowledgments in a virtual-circuit network



### Teardown Phase

In this phase, source A, after sending all frames to B, sends a special frame called a *teardown request*. Destination B responds with a teardown confirmation frame. All switches delete the corresponding entry from their tables.

### Efficiency

As we said before, resource reservation in a virtual-circuit network can be made during the setup or can be on demand during the data transfer phase. In the first case, the delay for each packet is the same; in the second case, each packet may encounter different delays. There is one big advantage in a virtual-circuit network even if resource allocation is on demand. The source can check the availability of the resources, without actually reserving it. Consider a family that wants to dine at a restaurant. Although the restaurant may not accept reservations (allocation of the tables is on demand), the family can call and find out the waiting time. This can save the family time and effort.

### Delay in Virtual-Circuit Networks

In a virtual-circuit network, there is a one-time delay for setup and a one-time delay for teardown. If resources are allocated during the setup phase, there is no wait time for individual packets. Below Figure shows the delay for a packet traveling through two switches in a virtual-circuit network.

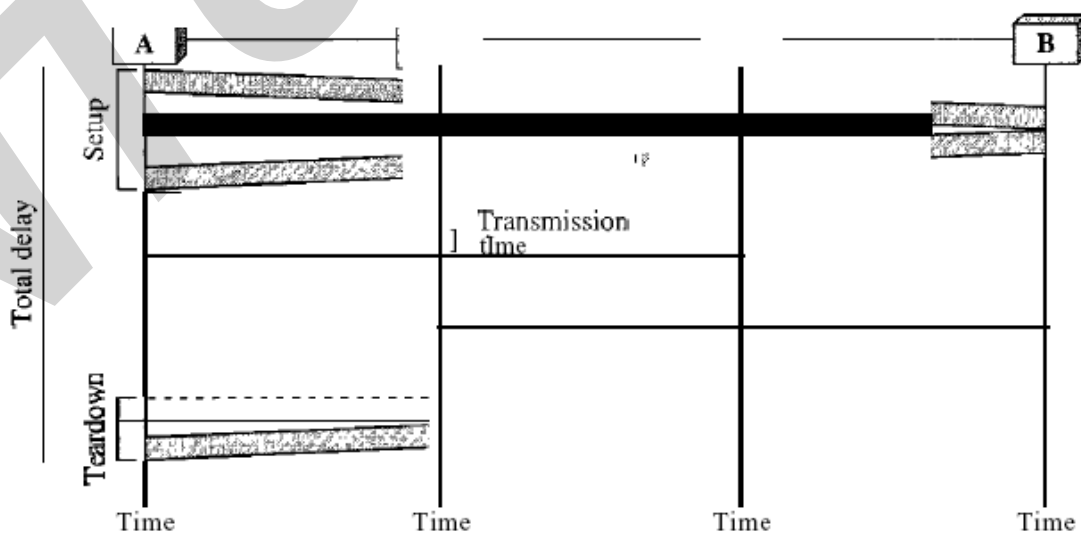

Fig: Delay in a virtual-circuit network

The packet is traveling through two switches (routers). There are three transmission times ( $3T$ ), three propagation times ( $3t$ ), data transfer depicted by the sloping lines, a setup delay (which includes transmission and propagation in two directions), and a teardown delay (which includes transmission and propagation in one direction). We ignore the processing time in each switch. The total delay time is

$$\text{Total delay} = 3T + 3t + \text{setup delay} + \text{teardown delay}$$

## UNIT – III

### 3.1 Framing:

To provide service to the network layer, the data link layer must use the service provided to it by the physical layer. What the physical layer does is accept a raw bit stream and attempt to deliver it to the destination. This bit stream is not guaranteed to be error free. The number of bits received may be less than, equal to, or more than the number of bits transmitted, and they may have different values. It is up to the data link layer to detect and, if necessary, correct errors. The usual approach is for the data link layer to break the bit stream up into discrete frames and compute the checksum for each frame. When a frame arrives at the destination, the checksum is recomputed. If the newly computed checksum is different from the one contained in the frame, the data link layer knows that an error has occurred and takes steps to deal with it (e.g., discarding the bad frame and possibly also sending back an error report).

Breaking the bit stream up into frames is more difficult than it at first appears. One way to achieve this framing is to insert time gaps between frames, much like the spaces between words in ordinary text. However, networks rarely make any guarantees about timing, so it is possible these gaps might be squeezed out or other gaps might be inserted during transmission. Since it is too risky to count on timing to mark the start and end of each frame, other methods have been devised. We will look at four methods:

1. Character count.
2. Flag bytes with byte stuffing.
3. Starting and ending flags, with bit stuffing.
4. Physical layer coding violations.

The first framing method uses a field in the header to specify the number of characters in the frame. When the data link layer at the destination sees the character count, it knows how many characters follow and hence where the end of the frame is. This technique is shown in Fig.3.1(a) for four frames of sizes 5, 5, 8, and 8 characters, respectively.

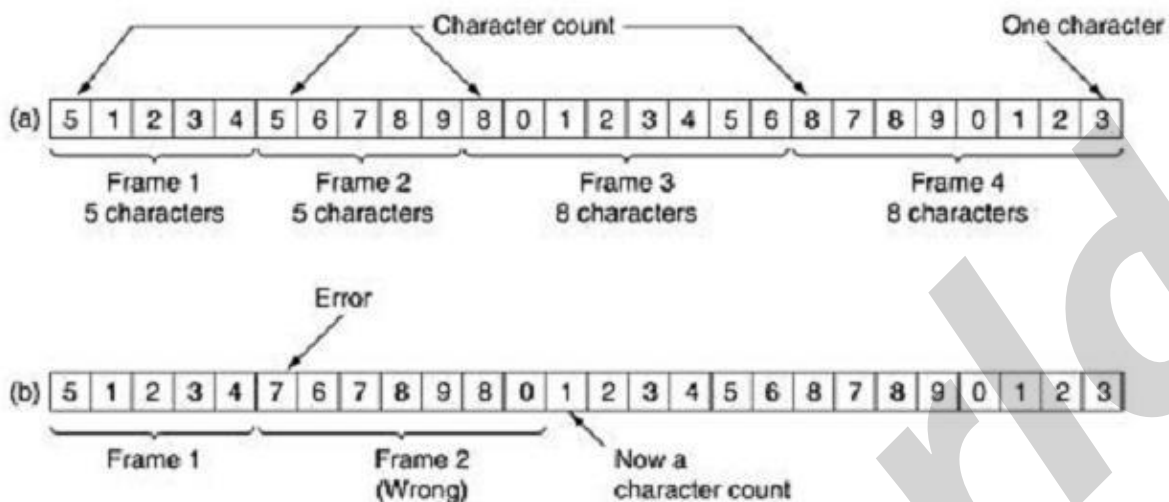

**Fig.3.1 A character stream. (a) Without errors. (b) With one error.**

The trouble with this algorithm is that the count can be garbled by a transmission error. For example, if the character count of 5 in the second frame of Fig. 3.1(b) becomes a 7, the destination will get out of synchronization and will be unable to locate the start of the next frame. Even if the checksum is incorrect so the destination knows that the frame is bad, it still has no way of telling where the next frame starts. Sending a frame back to the source asking for a retransmission does not help either, since the destination does not know how many characters to skip over to get to the start of the retransmission. For this reason, the character count method is rarely used anymore.

The second framing method gets around the problem of resynchronization after an error by having each frame start and end with special bytes. In the past, the starting and ending bytes were different, but in recent years most protocols have used the same byte, called a flag byte, as both the starting and ending delimiter, as shown in Fig. 3.2(a) as FLAG. In this way, if the receiver ever loses synchronization, it can just search for the flag byte to find the end of the current frame. Two consecutive flag bytes indicate the end of one frame and start of the next one.

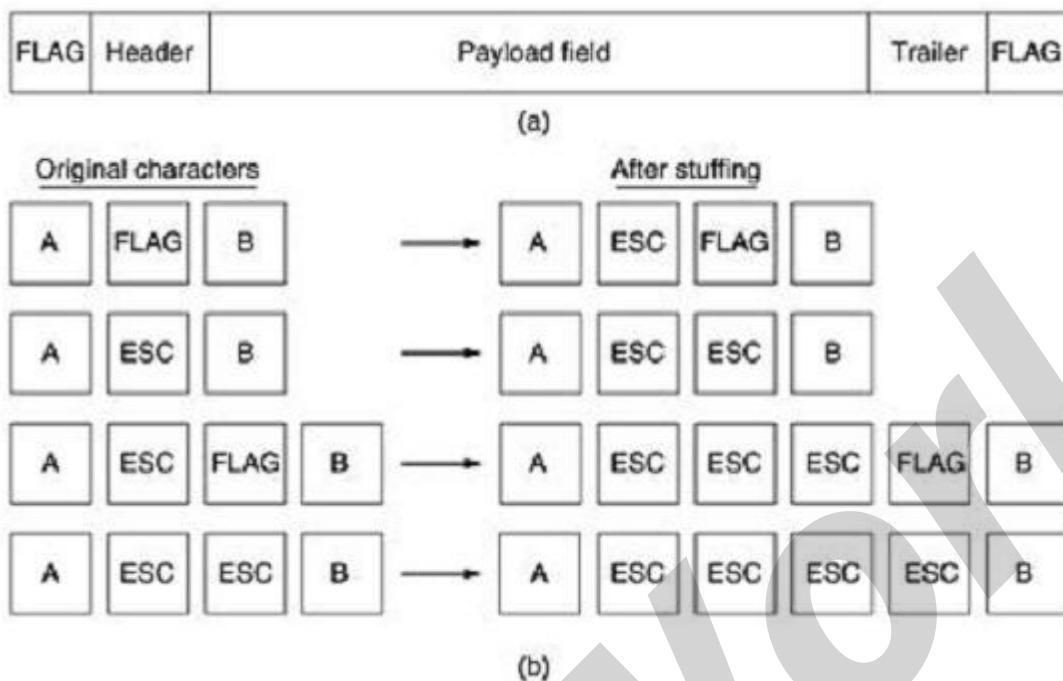

**Fig. 3.2 (a) A frame delimited by flag bytes (b) Four examples of byte sequences before and after byte stuffing.**

A serious problem occurs with this method when binary data, such as object programs or floating-point numbers, are being transmitted. It may easily happen that the flag byte's bit pattern occurs in the data. This situation will usually interfere with the framing. One way to solve this problem is to have the sender's data link layer insert a special escape byte (ESC) just before each "accidental" flag byte in the data. The data link layer on the receiving end removes the escape byte before the data are given to the network layer. This technique is called byte stuffing or character stuffing. Thus, a framing flag byte can be distinguished from one in the data by the absence or presence of an escape byte before it.

Of course, the next question is: What happens if an escape byte occurs in the middle of the data? The answer is that it, too, is stuffed with an escape byte. Thus, any single escape byte is part of an escape sequence, whereas a doubled one indicates that a single escape occurred naturally in the data. Some examples are shown in Fig. 3.3(b). In all cases, the byte sequence delivered after de stuffing is exactly the same as the original byte sequence.

The byte-stuffing scheme depicted in Fig. 3.3 is a slight simplification of the one used in the PPP protocol that most home computers use to communicate with their Internet service provider.

A major disadvantage of using this framing method is that it is closely tied to the use of 8-bit characters. Not all character codes use 8-bit characters. For example UNICODE uses 16-bit characters, As networks developed, the disadvantages of embedding the character code length in the framing mechanism became more and more obvious, so a new technique had to be developed to allow arbitrary sized characters.

The new technique allows data frames to contain an arbitrary number of bits and allows character codes with an arbitrary number of bits per character. It works like this. Each frame begins and ends with a special bit pattern, 01111110 (in fact, a flag byte). Whenever the sender's data link layer encounters five consecutive 1s in the data, it automatically stuffs a 0 bit into the outgoing bit stream. This bit stuffing is analogous to byte stuffing, in which an escape byte is stuffed into the outgoing character stream before a flag byte in the data.

When the receiver sees five consecutive incoming 1 bits, followed by a 0 bit, it automatically destuffs (i.e., deletes) the 0 bit. Just as byte stuffing is completely transparent to the network layer in both computers, so is bit stuffing. If the user data contain the flag pattern, 01111110, this flag is transmitted as 011111010 but stored in the receiver's memory as 01111110.

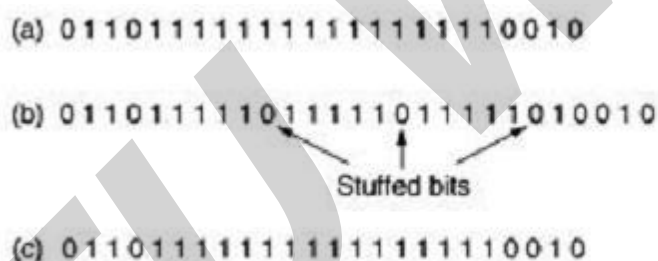

**Figure 3.3 Bit stuffing. (a) The original data. (b) The data as they appear on the line. (c) The data as they are stored in the receiver's memory after destuffing.**

With bit stuffing, the boundary between two frames can be unambiguously recognized by the flag pattern. Thus, if the receiver loses track of where it is, all it has to do is scan the input for flag sequences, since they can only occur at frame boundaries and never within the data. The last method of framing is only applicable to networks in which the encoding on the physical medium contains some redundancy. For example, some LANs encode 1 bit of data by using 2 physical bits. Normally, a 1 bit is a high-low pair and a 0 bit is a low-high pair. The scheme means that every data bit has a transition in the middle, making it easy for the receiver to locate the bit

boundaries. The combinations high-high and low-low are not used for data but are used for delimiting frames in some protocols.

As a final note on framing, many data link protocols use combination of a character count with one of the other methods for extra safety. When a frame arrives, the count field is used to locate the end of the frame. Only if the appropriate delimiter is present at that position and the checksum is correct is the frame accepted as valid. Otherwise, the input stream is scanned for the next delimiter.

### **3.2 Error correction and detection at the data link layer.**

#### **3.2.1 Error-Correcting Codes:**

Network designers have developed two basic strategies for dealing with errors. One way is to include enough redundant information along with each block of data sent, to enable the receiver to deduce what the transmitted data must have been. The other way is to include only enough redundancy to allow the receiver to deduce that an error occurred, but not which error, and have it request a retransmission. The former strategy uses error-correcting codes and the latter uses error-detecting codes. The use of error-correcting codes is often referred to as forward error correction.

Each of these techniques occupies a different ecological niche. On channels that are highly reliable, such as fiber, it is cheaper to use an error detecting code and just retransmit the occasional block found to be faulty. However, on channels such as wireless links that make many errors, it is better to add enough redundancy to each block for the receiver to be able to figure out what the original block was, rather than relying on a retransmission, which itself may be in error.

To understand how errors can be handled, it is necessary to look closely at what an error really is. Normally, a frame consists of  $m$  data (i.e., message) bits and  $r$  redundant, or check, bits. Let the total length be  $n$  (i.e.,  $n = m + r$ ). An  $n$ -bit unit containing data and check bits is often referred to as an  $n$ -bit codeword.

Given any two code words, say, 10001001 and 10110001, it is possible to determine how many corresponding bits differ. In this case, 3 bits differ. To determine how many bits differ, just exclusive OR the two code words and count the number of 1 bits in the result, for example:

The number of bit positions in which two code words differ is called the Hamming distance. Its significance is that if two codewords are a Hamming distance  $d$  apart, it will require  $d$  single-bit errors to convert one into the other.

In most data transmission applications, all  $2^m$  possible data messages are legal, but due to the way the check bits are computed, not all of the  $2^n$  possible codewords are used. Given the algorithm for computing the check bits, it is possible to construct a complete list of the legal codewords, and from this list find the two codewords whose Hamming distance is minimum. This distance is the Hamming distance of the complete code. The error-detecting and error-correcting properties of a code depend on its Hamming distance. To detect  $d$  errors, you need a distance  $d + 1$  code because with such a code there is no way that  $d$  single-bit errors can change a valid codeword into another valid codeword. When the receiver sees an invalid codeword, it can tell that a transmission error has occurred. Similarly, to correct  $d$  errors, you need a distance  $2d + 1$  code because that way the legal codewords are so far apart that even with  $d$  changes, the original codeword is still closer than any other codeword, so it can be uniquely determined. As a simple example of an error-detecting code, consider a code in which a single parity bit is appended to the data. The parity bit is chosen so that the number of 1 bits in the codeword is even (or odd). For example, when 1011010 is sent in even parity, a bit is added to the end to make it 10110100. With odd parity 1011010 becomes 10110101. A code with a single parity bit has a distance 2, since any single-bit error produces a codeword with the wrong parity. It can be used to detect single errors.

As a simple example of an error-correcting code, consider a code with only four valid codewords: 0000000000, 0000011111, 1111100000, and 1111111111

This code has a distance 5, which means that it can correct double errors. If the codeword 0000000111 arrives, the receiver knows that the original must have been 0000011111. If, however, a triple error changes 0000000000 into 0000000111, the error will not be corrected properly.

Imagine that we want to design a code with  $m$  message bits and  $r$  check bits that will allow all single errors to be corrected. Each of the  $2^m$  legal messages has  $n$  illegal codewords at a distance 1 from it. These are formed by systematically inverting each of the  $n$  bits in the  $n$ -bit codeword formed from it. Thus, each of the  $2^m$  legal messages requires  $n + 1$  bit patterns dedicated to it. Since the total number of bit patterns is  $2^n$ , we must have  $(n + 1)2^m \leq 2^n$ .



Using  $n = m + r$ , this requirement becomes  $(m + r + 1) \leq 2r$ . Given  $m$ , this puts a lower limit on the number of check bits needed to correct single errors. This theoretical lower limit can, in fact, be achieved using a method due to Hamming (1950).

The bits of the codeword are numbered consecutively, starting with bit 1 at the left end, bit 2 to its immediate right, and so on. The bits that are powers of 2 (1, 2, 4, 8, 16, etc.) are check bits. The rest (3, 5, 6, 7, 9, etc.) are filled up with the  $m$  data bits. Each check bit forces the parity of some collection of bits, including itself, to be even (or odd). A bit may be included in several parity computations. To see which check bits the data bit in position  $k$  contributes to, rewrite  $k$  as a sum of powers of 2. For example,  $11 = 1 + 2 + 8$  and  $29 = 1 + 4 + 8 + 16$ . A bit is checked by just those check bits occurring in its expansion (e.g., bit 11 is checked by bits 1, 2, and 8). When a codeword arrives, the receiver initializes a counter to zero. It then examines each check bit,  $k$  ( $k = 1, 2, 4, 8 \dots$ ), to see if it has the correct parity. If not, the receiver adds  $k$  to the counter. If the counter is zero after all the check bits have been examined (i.e., if they were all correct), the codeword is accepted as valid. If the counter is nonzero, it contains the number of the incorrect bit. For example, if check bits 1, 2, and 8 are in error, the inverted bit is 11, because it is the only one checked by bits 1, 2, and 8. Figure 4.1 shows some 7-bit ASCII characters encoded as 11-bit codewords using a Hamming code. Remember that the data are found in bit positions 3, 5, 6, 7, 9, 10, and 11.

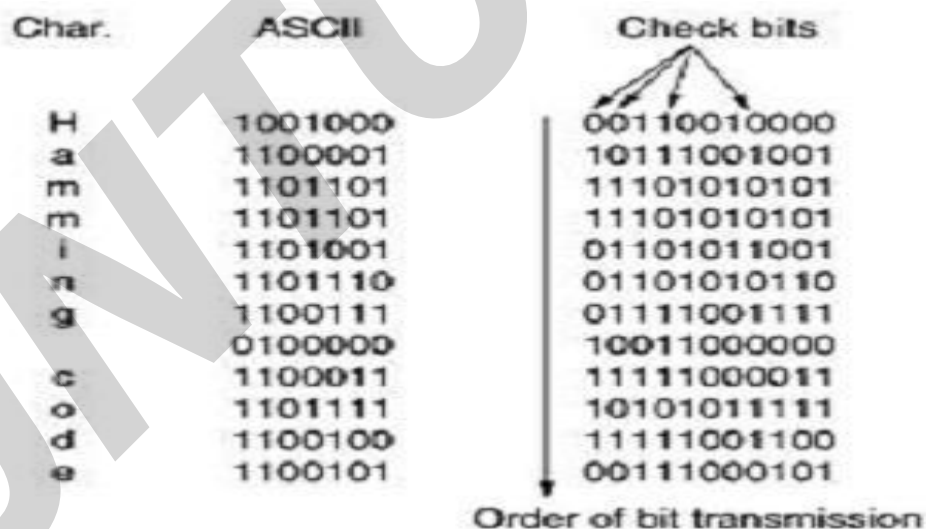

**Fig.4.1. Use of a Hamming code to correct burst errors**

Hamming codes can only correct single errors. However, there is a trick that can be used to permit Hamming codes to correct burst errors. A sequence of  $k$  consecutive code words is arranged as a matrix, one codeword per row. Normally, the data would be transmitted one codeword at a time, from left to right. To correct burst errors, the data should be transmitted one column at a time, starting with the leftmost column. When all  $k$  bits have been sent, the second column is sent, and so on, as indicated in Fig.4.1. When the frame arrives at the receiver, the matrix is reconstructed, one column at a time. If a burst error of length  $k$  occurs, at most 1 bit in each of the  $k$  codewords will have been affected, but the Hamming code can correct one error per codeword, so the entire block can be restored. This method uses  $kr$  check bits to make blocks of  $km$  data bits immune to a single burst error of length  $k$  or less.

### 3.2.2 Error-Detecting Codes:

Error-correcting codes are widely used on wireless links, which are notoriously noisy and error prone when compared to copper wire or optical fibers. Without error-correcting codes, it would be hard to get anything through. However, over copper wire or fiber, the error rate is much lower, so error detection and retransmission is usually more efficient there for dealing with the occasional error. As a simple example, consider a channel on which errors are isolated and the error rate is  $10^{-6}$  per bit. Let the block size be 1000 bits. To provide error correction for 1000-bit blocks, 10 check bits are needed; a megabit of data would require 10,000 check bits. To merely detect a block with a single 1-bit error, one parity bit per block will suffice. Once every 1000 blocks, an extra block (1001 bits) will have to be transmitted. The total overhead for the error detection + retransmission method is only 2001 bits per megabit of data, versus 10,000 bits for a Hamming code.

If a single parity bit is added to a block and the block is badly garbled by a long burst error, the probability that the error will be detected is only 0.5, which is hardly acceptable.

The odds can be improved considerably if each block to be sent is regarded as rectangular matrix  $n$  bits wide and  $k$  bits high, as described above. A parity bit is computed separately for each column and affixed to the matrix as the last row. The matrix is then transmitted one row at a time. When the block arrives, the receiver checks all the parity bits. If any one of them is wrong, the receiver requests a retransmission of the block. Additional retransmissions are requested as needed until an entire block is received without any parity errors. This method can detect a single burst of length  $n$ , since only 1 bit per column will be changed. A burst of length  $n + 1$  will pass

undetected, however, if the first bit is inverted, the last bit is inverted, and all the other bits are correct. (A burst error does not imply that all the bits are wrong; it just implies that at least the first and last are wrong.) If the block is badly garbled by a long burst or by multiple shorter bursts, the probability that any of the  $n$  columns will have the correct parity, by accident, is 0.5, so the probability of a bad block being accepted when it should not be is  $2^{-n}$ . Although the above scheme may sometimes be adequate, in practice, another method is in widespread use: the polynomial code, also known as a CRC (Cyclic Redundancy Check).

Polynomial codes are based upon treating bit strings as representations of polynomials with coefficients of 0 and 1 only. A  $k$ -bit frame is regarded as the coefficient list for a polynomial with  $k$  terms, ranging from  $x^{k-1}$  to  $x^0$ . Such a polynomial is said to be of degree  $k - 1$ . The highorder (leftmost) bit is the coefficient of  $x^{k-1}$ ; the next bit is the coefficient of  $x^{k-2}$ , and so on. For example, 110001 has 6 bits and thus represent a six-term polynomial with coefficients 1, 1, 0, 0, 0, and 1:  $x^5 + x^4 + x^0$ .

Polynomial arithmetic is done modulo 2, according to the rules of algebraic field theory. There are no carries for addition or borrows for subtraction. Both addition and subtraction are identical to exclusive OR. For example: Long division is carried out the same way as it is in binary except that the subtraction is done modulo 2, as above. A divisor is said "to go into" a dividend if the dividend has as many bits as the divisor. When the polynomial code method is employed, the sender and receiver must agree upon a generator polynomial,  $G(x)$ , in advance. Both the high- and low-order bits of the generator must be 1. To compute the checksum for some frame with  $m$  bits, corresponding to the polynomial  $M(x)$ , the frame must be longer than the generator polynomial. The idea is to append a checksum to the end of the frame in such a way that the polynomial represented by the checksummed frame is divisible by  $G(x)$ . When the receiver gets the checksummed frame, it tries dividing it by  $G(x)$ . If there is a remainder, there has been a transmission error.

The algorithm for computing the checksum is as follows:

1. Let  $r$  be the degree of  $G(x)$ . Append  $r$  zero bits to the low-order end of the frame so it now contains  $m + r$  bits and corresponds to the polynomial  $x^r M(x)$ .
2. Divide the bit string corresponding to  $G(x)$  into the bit string corresponding to  $x^r M(x)$ , using modulo 2 division.

3. Subtract the remainder (which is always  $r$  or fewer bits) from the bit string corresponding to  $M(x)$  using modulo 2 subtractions. The result is the checksummed frame to be transmitted. Call its polynomial  $T(x)$ .

Figure illustrates the calculation for a frame 1101011011 using the generator  $G(x) = x^4 + x + 1$ .

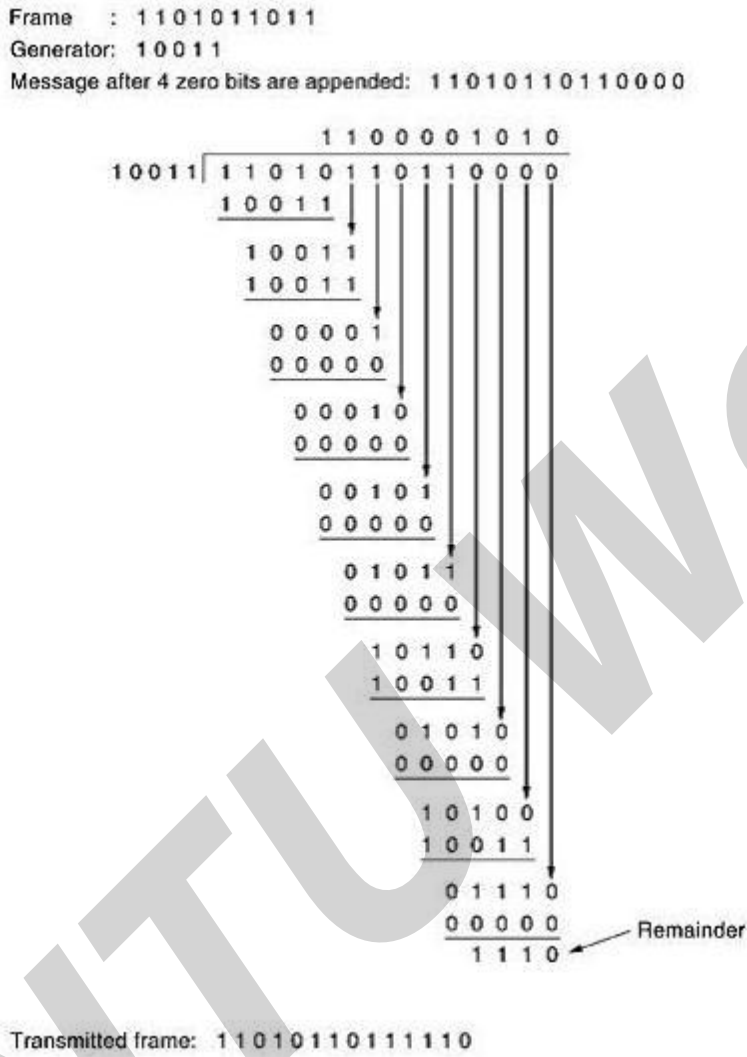

**Fig.5.1. Calculation of the polynomial code checksum**

### 3.3 Elementary Data Link Layer Protocols

#### 3.3.1 An Unrestricted Simplex Protocol:

As an initial example we will consider a protocol that is as simple as it can be. Data are transmitted in one direction only. Both the transmitting and receiving network layers are always ready. Processing time can be ignored. Infinite buffer space is available. And best of all, the communication channel between the data link layers never damages or loses frames. This thoroughly unrealistic protocol, which we will nickname "utopia" .

The protocol consists of two distinct procedures, a sender and a receiver. The sender runs in the data link layer of the source machine, and the receiver runs in the data link layer of the destination machine. No sequence numbers or acknowledgements are used here, so MAX\_SEQ is not needed. The only event type possible is frame\_arrival (i.e., the arrival of an undamaged frame).

The sender is in an infinite while loop just pumping data out onto the line as fast as it can. The body of the loop consists of three actions: go fetch a packet from the (always obliging) network layer, construct an outbound frame using the variable s, and send the frame on its way. Only the info field of the frame is used by this protocol, because the other fields have to do with error and flow control and there are no errors or flow control restrictions here. The receiver is equally simple. Initially, it waits for something to happen, the only possibility being the arrival of an undamaged frame. Eventually, the frame arrives and the procedure wait\_for\_event returns, with event set to frame\_arrival (which is ignored anyway). The call to from\_physical\_layer removes the newly arrived frame from the hardware buffer and puts it in the variable r, where the receiver code can get at it. Finally, the data portion is passed on to the network layer, and the data link layer settles back to wait for the next frame, effectively suspending itself until the frame arrives.

#### 3.3.2 A Simplex Stop-and-Wait Protocol:

The main problem we have to deal with here is how to prevent the sender from flooding the receiver with data faster than the latter is able to process them. In essence, if the receiver requires a time  $\Delta t$  to execute from\_physical\_layer plus to\_network\_layer, the sender must transmit at an average rate less than one frame per time  $\Delta t$ . Moreover, if we assume that no automatic buffering and queuing are done within the receiver's hardware, the sender must never transmit a new frame until the old one has been fetched by from\_physical\_layer, lest the new one overwrite the old

one. In certain restricted circumstances (e.g., synchronous transmission and a receiving data link layer fully dedicated to processing the one input line), it might be possible for the sender to simply insert a delay into protocol 1 to slow it down sufficiently to keep from swamping the receiver. However, more usually, each data link layer will have several lines to attend to, and the time interval between a frame arriving and its being processed may vary considerably. If the network designers can calculate the worst-case behavior of the receiver, they can program the sender to transmit so slowly that even if every frame suffers the maximum delay, there will be no overruns. The trouble with this approach is that it is too conservative. It leads to a bandwidth utilization that is far below the optimum, unless the best and worst cases are almost the same (i.e., the variation in the data link layer's reaction time is small).

A more general solution to this dilemma is to have the receiver provide feedback to the sender. After having passed a packet to its network layer, the receiver sends a little dummy frame back to the sender which, in effect, gives the sender permission to transmit the next frame. After having sent a frame, the sender is required by the protocol to bide its time until the little dummy (i.e., acknowledgement) frame arrives. Using feedback from the receiver to let the sender know when it may send more data is an example of the flow control mentioned earlier.

Protocols in which the sender sends one frame and then waits for an acknowledgement before proceeding are called stop-and-wait.

### **3.3.3 A Simplex Protocol for a Noisy Channel:**

Protocols in which the sender waits for a positive acknowledgement before advancing to the next data item are often called PAR (Positive Acknowledgement with Retransmission) or ARQ (Automatic Repeat reQuest). Like protocol 2, this one also transmits data only in one direction.

## UNIT – IV

### 4.1 Sliding Window Protocols:

In the previous protocols, data frames were transmitted in one direction only. In most practical situations, there is a need for transmitting data in both directions. One way of achieving full duplex data transmission is to have two separate communication channels and use each one for simplex data traffic (in different directions). If this is done, we have two separate physical circuits, each with a "forward" channel (for data) and a "reverse" channel (for acknowledgements). In both cases the bandwidth of the reverse channel is almost entirely wasted. In effect, the user is paying for two circuits but using only the capacity of one. A better idea is to use the same circuit for data in both directions. After all, in protocols 2 and 3 it was already being used to transmit frames both ways, and the reverse channel has the same capacity as the forward channel. In this model the data frames from A to B are intermixed with the acknowledgement frames from A to B. By looking at the kind field in the header of an incoming frame, the receiver can tell whether the frame is data or acknowledgement.

Although interleaving data and control frames on the same circuit is an improvement over having two separate physical circuits, yet another improvement is possible. When a data frame arrives, instead of immediately sending a separate control frame, the receiver restrains itself and waits until the network layer passes it the next packet. The acknowledgement is attached to the outgoing data frame (using the ack field in the frame header). In effect, the acknowledgement gets a free ride on the next outgoing data frame. The technique of temporarily delaying outgoing acknowledgements so that they can be hooked onto the next outgoing data frame is known as piggybacking. The principal advantage of using piggybacking over having distinct acknowledgement frames is a better use of the available channel bandwidth. The ack field in the frame header costs only a few bits, whereas a separate frame would need a header, the acknowledgement, and a checksum. In addition, fewer frames sent means fewer "frame arrival" interrupts, and perhaps fewer buffers in the receiver, depending on how the receiver's software is organized. In the next protocol to be examined, the piggyback field costs only 1 bit in

the frame header. It rarely costs more than a few bits.

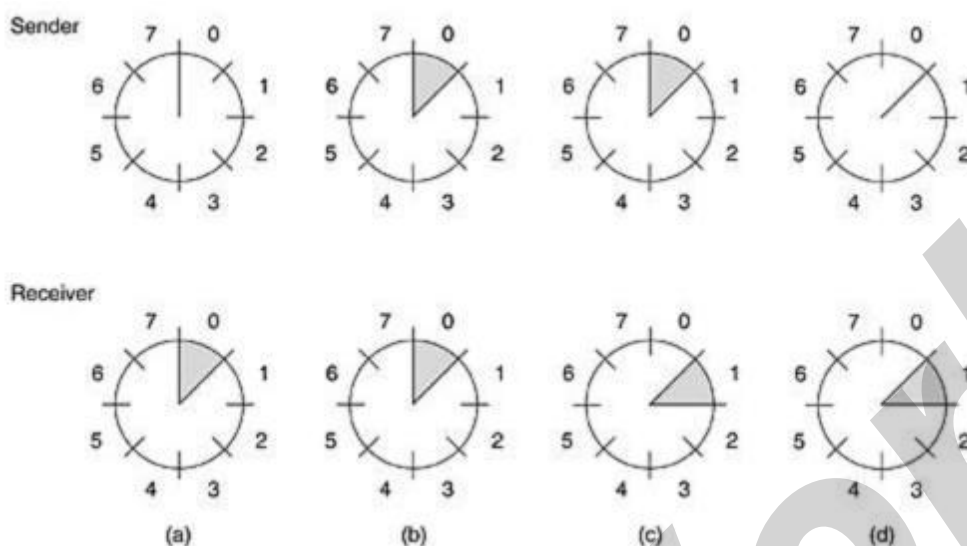

**Fig.8. A sliding window of size 1, with a 3-bit sequence number (a) Initially (b) After the first frame has been sent (c) After the first frame has been received (d) After the first acknowledgement has been received.**

Since frames currently within the sender's window may ultimately be lost or damaged in transit, the sender must keep all these frames in its memory for possible retransmission. Thus, if the maximum window size is  $n$ , the sender needs  $n$  buffers to hold the unacknowledged frames. If the window ever grows to its maximum size, the sending data link layer must forcibly shut off the network layer until another buffer becomes free. The receiving data link layer's window corresponds to the frames it may accept. Any frame falling outside the window is discarded without comment. When a frame whose sequence number is equal to the lower edge of the window is received, it is passed to the network layer, an acknowledgement is generated, and the window is rotated by one. Unlike the sender's window, the receiver's window always remains at its initial size. Note that a window size of 1 means that the data link layer only accepts frames in order, but for larger windows this is not so. The network layer, in contrast, is always fed data in the proper order, regardless of the data link layer's window size. Figure 8 shows an example with a maximum window size of 1. Initially, no frame are outstanding, so the lower and upper edges of the sender's window are equal, but as time goes on, the situation progresses as shown.



#### 4.1.1 A One-Bit Sliding Window Protocol:

Before tackling the general case, let us first examine a sliding window protocol with a maximum window size of 1. Such a protocol uses stop-and-wait since the sender transmits a frame and waits for its acknowledgement before sending the next one. Figure 9.1 depicts such a protocol. Like the others, it starts out by defining some variables. `Next_frame_to_send` tells which frame the sender is trying to send. Similarly, `frame_expected` tells which frame the receiver is expecting. In both cases, 0 and 1 are the only possibilities.

Under normal circumstances, one of the two data link layers goes first and transmits the first frame. In other words, only one of the data link layer programs should contain the `to_physical_layer` and `start_timer` procedure calls outside the main loop. In the event that both data link layers start off simultaneously, a peculiar situation arises, as discussed later. The starting machine fetches the first packet from its network layer, builds a frame from it, and sends it. When this (or any) frame arrives, the receiving data link layer checks to see if it is a duplicate, just as in protocol 3. If the frame is the one expected, it is passed to the network layer and the receiver's window is slid up. The acknowledgement field contains the number of the last frame received without error. If this number agrees with the sequence number of the frame the sender is trying to send, the sender knows it is done with the frame stored in buffer and can fetch the next packet from its network layer. If the sequence number disagrees, it must continue trying to send the same frame. Whenever a frame is received, a frame is also sent back. Now let us examine protocol 4 to see how resilient it is to pathological scenarios. Assume that computer A is trying to send its frame 0 to computer B and that B is trying to send its frame 0 to A. Suppose that A sends frame 0 to B, but A's timeout interval is a little too short. Consequently, A may time out repeatedly, sending a series of identical frames, all with `seq = 0` and `ack = 1`.

When the first valid frame arrives at computer B, it will be accepted and `frame_expected` will be set to 1. All the subsequent frames will be rejected because B is now expecting frames with sequence number 1, not 0. Furthermore, since all the duplicates have `ack = 1` and B is still waiting for an acknowledgement of 0, B will not fetch a new packet from its network layer. After every rejected duplicate comes in, B sends A a frame containing `seq = 0` and `ack = 0`. Eventually, one of these arrives correctly at A, causing A to begin sending the next packet. No combination of lost frames or premature timeouts can cause the protocol to deliver duplicate packets to either network layer, to skip a packet, or to deadlock.

However, a peculiar situation arises if both sides simultaneously send an initial packet. This synchronization difficulty is illustrated by Fig.9.2. In part (a), the normal operation of the protocol is shown. In (b) the peculiarity is illustrated. If B waits for A's first frame before sending one of its own, the sequence is as shown in (a), and every frame is accepted. However, if A and B simultaneously initiate communication, their first frames cross, and the data link layers then get into situation (b). In (a) each frame arrival brings a new packet for the network layer; there are no duplicates. In (b) half of the frames contain duplicates, even though there are no transmission errors. Similar situations can occur as a result of premature timeouts, even when one side clearly starts first. In fact, if multiple premature timeouts occur, frames may be sent three or more times.

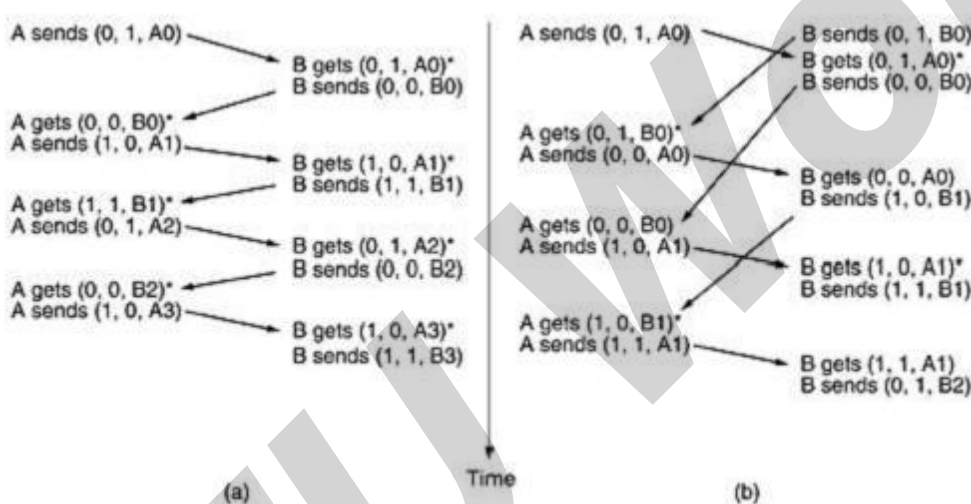

**Fig.9.2 Two scenarios for protocol 4 (a) Normal case (b) Abnormal case. The notation is (seq, ack, packet number). An asterisk indicates where a network layer accepts a packet.**

#### 4.1.2 Selective repeat:

##### A Protocol Using Go Back N:

Until now we have made the tacit assumption that the transmission time required for a frame to arrive at the receiver plus the transmission time for the acknowledgement to come back is negligible. Sometimes this assumption is clearly false. In these situations the long round-trip time can have important implications for the efficiency of the bandwidth utilization. As an example, consider a 50-kbps satellite channel with a 500-msec round-trip propagation delay. Let

us imagine trying to use protocol 4 to send 1000-bit frames via the satellite. At  $t = 0$  the sender starts sending the first frame. At  $t = 20$  msec the frame has been completely sent. Not until  $t = 270$  msec has the frame fully arrived at the receiver, and not until  $t = 520$  msec has the acknowledgement arrived back at the sender, under the best of circumstances (no waiting in the receiver and a short acknowledgement frame). This means that the sender was blocked during  $500/520$  or 96 percent of the time. In other words, only 4 percent of the available bandwidth was used. Clearly, the combination of a long transit time, high bandwidth, and short frame length is disastrous in terms of efficiency. The problem described above can be viewed as a consequence of the rule requiring a sender to wait for an acknowledgement before sending another frame. If we relax that restriction, much better efficiency can be achieved. Basically, the solution lies in allowing the sender to transmit up to  $w$  frames before blocking, instead of just 1. With an appropriate choice of  $w$  the sender will be able to continuously transmit frames for a time equal to the round-trip transit time without filling up the window. In the example above,  $w$  should be at least 26. The sender begins sending frame 0 as before. By the time it has finished sending 26 frames, at  $t = 520$ , the acknowledgement for frame 0 will have just arrived. Thereafter, acknowledgements arrive every 20 msec, so the sender always gets permission to continue just when it needs it. At all times, 25 or 26 unacknowledged frames are outstanding. Put in other terms, the sender's maximum window size is 26.

The need for a large window on the sending side occurs whenever the product of bandwidth  $\times$  round-trip-delay is large. If the bandwidth is high, even for a moderate delay, the sender will exhaust its window quickly unless it has a large window. If the delay is high (e.g., on a geostationary satellite channel), the sender will exhaust its window even for a moderate bandwidth. The product of these two factors basically tells what the capacity of the pipe is, and the sender needs the ability to fill it without stopping in order to operate at peak efficiency. This technique is known as pipelining. If the channel capacity is  $b$  bits/sec, the frame size  $l$  bits, and the round-trip propagation time  $R$  sec, the time required to transmit a single frame is  $l/b$  sec. After the last bit of a data frame has been sent, there is a delay of  $R/2$  before that bit arrives at the receiver and another delay of at least  $R/2$  for the acknowledgement to come back, for a total delay of  $R$ . In stop-and-wait the line is busy for  $l/b$  and idle for  $R$ , giving

If  $l < bR$ , the efficiency will be less than 50 percent. Since there is always a nonzero delay for the

acknowledgement to propagate back, pipelining can, in principle, be used to keep the line busy during this interval, but if the interval is small, the additional complexity is not worth the trouble. Pipelining frames over an unreliable communication channel raises some serious issues. First, what happens if a frame in the middle of a long stream is damaged or lost? Large numbers of succeeding frames will arrive at the receiver before the sender even finds out that anything is wrong. When a damaged frame arrives at the receiver, it obviously should be discarded, but what should the receiver do with all the correct frames following it? Remember that the receiving data link layer is obligated to hand packets to the network layer in sequence. In Two basic approaches are available for dealing with errors in the presence of pipelining. One way, called go back n, is for the receiver simply to discard all subsequent frames, sending no acknowledgements for the discarded frames. This strategy corresponds to a receive window of size 1. In other words, the data link layer refuses to accept any frame except the next one it must give to the network layer. If the sender's window fills up before the timer runs out, the pipeline will begin to empty. Eventually, the sender will time out and retransmit all unacknowledged frames in order, starting with the damaged or lost one. This approach can waste a lot of bandwidth if the error rate is high.

In Fig.10.1 (a) we see go back n for the case in which the receiver's window is large. Frames 0 and 1 are correctly received and acknowledged. Frame 2, however, is damaged or lost. The sender, unaware of this problem, continues to send frames until the timer for frame 2 expires. Then it backs up to frame 2 and starts all over with it, sending 2, 3, 4, etc. all over again. The other general strategy for handling errors when frames are pipelined is called selective repeat. When it is used, a bad frame that is received is discarded, but good frames received after it are buffered. When the sender times out, only the oldest unacknowledged frame is retransmitted. If that frame arrives correctly, the receiver can deliver to the network layer, in sequence, all the frames it has buffered. Selective repeat is often combined with having the receiver send a negative acknowledgement (NAK) when it detects an error, for example, when it receives a checksum error or a frame out of sequence. NAKs stimulate retransmission before the corresponding timer expires and thus improve performance. In Fig.10.1 (b), frames 0 and 1 are again correctly received and acknowledged and frame 2 is lost. When frame 3 arrives at the receiver, the data link layer there notices that it has missed a frame, so it sends back a NAK for 2 but buffers 3. When frames 4 and 5 arrive, they, too, are buffered by the data link layer instead of being passed to the network layer. Eventually, the NAK 2 gets back to the sender, which

immediately resends frame 2. When that arrives, the data link layer now has 2, 3, 4, and 5 and can pass all of them to the network layer in the correct order. It can also acknowledge all frames up to and including 5, as shown in the figure. If the NAK should get lost, eventually the sender will time out for frame 2 and send it (and only it) of its own accord, but that may be a quite a while later. In effect, the NAK speeds up the retransmission of one specific frame.

Selective repeat corresponds to a receiver window larger than 1. Any frame within the window may be accepted and buffered until all the preceding ones have been passed to the network layer. This approach can require large amounts of data link layer memory if the window is large. These two alternative approaches are trade-offs between bandwidth and data link layer buffer space. Depending on which resource is scarcer, one or the other can be used. Figure 10.2 shows a pipelining protocol in which the receiving data link layer only accepts frames in order; frames following an error are discarded. In this protocol, for the first time we have dropped the assumption that the network layer always has an infinite supply of packets to send. When the network layer has a packet it wants to send, it can cause a `network_layer_ready` event to happen. However, to enforce the flow control rule of no more than `MAX_SEQ` unacknowledged frames outstanding at any time, the data link layer must be able to keep the network layer from bothering it with more work. The library procedures `enable_network_layer` and `disable_network_layer` do this job.

### **A Protocol Using Selective Repeat**

This protocol works well if errors are rare, but if the line is poor, it wastes a lot of bandwidth on retransmitted frames. An alternative strategy for handling errors is to allow the receiver to accept and buffer the frames following a damaged or lost one. Such a protocol does not discard frames merely because an earlier frame was damaged or lost. In this protocol, both sender and receiver maintain a window of acceptable sequence numbers. The sender's window size starts out at 0 and grows to some predefined maximum, `MAX_SEQ`. The receiver's window, in contrast, is always fixed in size and equal to `MAX_SEQ`. The receiver has a buffer reserved for each sequence number within its fixed window. Associated with each buffer is a bit (arrived) telling whether the buffer is full or empty. Whenever a frame arrives, its sequence number is checked by the function between to see if it falls within the window. If so and if it has not already been received, it is accepted and stored. This action is taken without regard to whether or not it contains the next

packet expected by the network layer. Of course, it must be kept within the data link layer and not passed to the network layer until all the lower-numbered frames have already been delivered to the network layer in the correct order.

#### 4.2 HDLC—High-Level Data Link Control:

These are a group of closely related protocols that are a bit old but are still heavily used. They are all derived from the data link protocol first used in the IBM mainframe world: SDLC (Synchronous Data Link Control) protocol. After developing SDLC, IBM submitted it to ANSI and ISO for acceptance as U.S. and international standards, respectively. ANSI modified it to become ADCCP (Advanced Data Communication Control Procedure), and ISO modified it to become HDLC (High-level Data Link Control). CCITT then adopted and modified HDLC for its LAP (Link Access Procedure) as part of the X.25 network interface standard but later modified it again to LAPB, to make it more compatible with a later version of HDLC. The nice thing about standards is that you have so many to choose from. Furthermore, if you do not like any of them, you can just wait for next year's model. These protocols are based on the same principles. All are bit oriented, and all use bit stuffing for data transparency. They differ only in minor, but nevertheless irritating, ways. The discussion of bit-oriented protocols that follows is intended as a general introduction. For the specific details of any one protocol, please consult the appropriate definition.

All the bit-oriented protocols use the frame structure shown in Fig.11.1. The Address field is primarily of importance on lines with multiple terminals, where it is used to identify one of the terminals. For point-to-point lines, it is sometimes used to distinguish commands from responses.

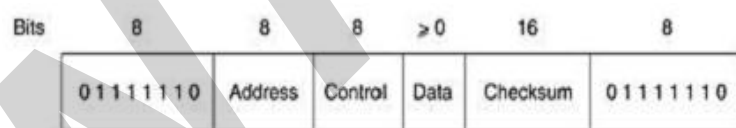

**Fig.11.1. Frame format for bit-oriented protocols**

The Control field is used for sequence numbers, acknowledgements, and other purposes, as discussed below.

The Data field may contain any information. It may be arbitrarily long, although the efficiency of the checksum falls off with increasing frame length due to the greater probability of multiple burst errors.

The Checksum field is a cyclic redundancy code. The frame is delimited with another flag sequence (01111110). On idle point-to-point lines, flag sequences are transmitted continuously. The minimum frame contains three fields and totals 32 bits, excluding the flags on either end. There are three kinds of frames: Information, Supervisory, and Unnumbered.

The contents of the Control field for these three kinds are shown in Fig.11.2. The protocol uses a sliding window, with a 3-bit sequence number. Up to seven unacknowledged frames may be outstanding at any instant. The Seq field in Fig.11.2 (a) is the frame sequence number. The Next field is a piggybacked acknowledgement. However, all the protocols adhere to the convention that instead of piggybacking the number of the last frame received correctly, they use the number of the first frame not yet received (i.e., the next frame expected). The choice of using the last frame received or the next frame expected is arbitrary; it does not matter which convention is used, provided that it is used consistently.

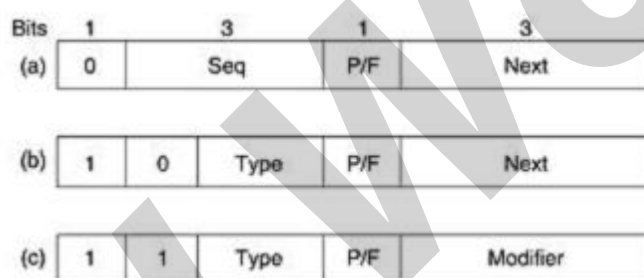

**Fig.11.2 Control field of (a) an information frame, (b) a supervisory frame, (c) an unnumbered frame**

The P/F bit stands for Poll/Final. It is used when a computer (or concentrator) is polling a group of terminals. When used as P, the computer is inviting the terminal to send data. All the frames sent by the terminal, except the final one, have the P/F bit set to P. The final one is set to F. In some of the protocols, the P/F bit is used to force the other machine to send a Supervisory frame immediately rather than waiting for reverse traffic onto which to piggyback the window information. The bit also has some minor uses in connection with the Unnumbered frames.

The various kinds of Supervisory frames are distinguished by the Type field. Type 0 is an acknowledgement frame (officially called RECEIVE READY) used to indicate the next frame expected. This frame is used when there is no reverse traffic to use for piggybacking.

**Type 1** is a negative acknowledgement frame (officially called REJECT). It is used to indicate that a transmission error has been detected. The Next field indicates the first frame in sequence not received correctly (i.e., the frame to be retransmitted). The sender is required to retransmit all outstanding frames starting at Next. This strategy is similar to our protocol 5 rather than our protocol 6.

**Type 2** is RECEIVE NOT READY. It acknowledges all frames up to but not including Next, just as RECEIVE READY does, but it tells the sender to stop sending. RECEIVE NOT READY is intended to signal certain temporary problems with the receiver, such as a shortage of buffers, and not as an alternative to the sliding window flow control. When the condition has been repaired, the receiver sends a RECEIVE READY, REJECT, or certain control frames.

**Type 3** is the SELECTIVE REJECT. It calls for retransmission of only the frame specified. In this sense it is like our protocol 6 rather than 5 and is therefore most useful when the sender's window size is half the sequence space size, or less. Thus, if a receiver wishes to buffer out-of-sequence frames for potential future use, it can force the retransmission of any specific frame using Selective Reject. HDLC and ADCCP allow this frame type, but SDLC and LAPB do not allow it (i.e., there is no Selective Reject), and type 3 frames are undefined.

The third class of frame is the Unnumbered frame. It is sometimes used for control purposes but can also carry data when unreliable connectionless service is called for. The various bit-oriented protocols differ considerably here, in contrast with the other two kinds, where they are nearly identical. Five bits are available to indicate the frame type, but not all 32 possibilities are used.

#### **4.3 PPP-The Point-to-Point Protocol:**

The Internet needs a point-to-point protocol for a variety of purposes, including router-to-router traffic and home user-to-ISP traffic. This protocol is PPP (Point-to-Point Protocol), which is defined in RFC 1661 and further elaborated on in several other RFCs (e.g., RFCs 1662 and 1663). PPP handles error detection, supports multiple protocols, allows IP addresses to be negotiated at connection time, permits authentication, and has many other features.

PPP provides three features:

1. A framing method that unambiguously delineates the end of one frame and the start of the next one. The frame format also handles error detection.



2. A link control protocol for bringing lines up, testing them, negotiating options, and bringing them down again gracefully when they are no longer needed. This protocol is called LCP (Link Control Protocol). It supports synchronous and asynchronous circuits and byte-oriented and bit-oriented encodings.
3. A way to negotiate network-layer options in a way that is independent of the network layer protocol to be used. The method chosen is to have a different NCP (Network Control Protocol) for each network layer supported.

To see how these pieces fit together, let us consider the typical scenario of a home user calling up an Internet service provider to make a home PC a temporary Internet host. The PC first calls the provider's router via a modem. After the router's modem has answered the phone and established a physical connection, the PC sends the router a series of LCP packets in the payload field of one or more PPP frames. These packets and their responses select the PPP parameters to be used.

Once the parameters have been agreed upon, a series of NCP packets are sent to configure the network layer. Typically, the PC wants to run a TCP/IP protocol stack, so it needs an IP address. There are not enough IP addresses to go around, so normally each Internet provider gets a block of them and then dynamically assigns one to each newly attached PC for the duration of its login session. If a provider owns  $n$  IP addresses, it can have up to  $n$  machines logged in simultaneously, but its total customer base may be many times that. The NCP for IP assigns the IP address. At this point, the PC is now an Internet host and can send and receive IP packets, just as hardwired hosts can. When the user is finished, NCP tears down the network layer connection and frees up the IP address. Then LCP shuts down the data link layer connection. Finally, the computer tells the modem to hang up the phone, releasing the physical layer connection.

The PPP frame format was chosen to closely resemble the HDLC frame format, since there was no reason to reinvent the wheel. The major difference between PPP and HDLC is that PPP is character oriented rather than bit oriented. In particular, PPP uses byte stuffing on dial-up modem lines, so all frames are an integral number of bytes. It is not possible to send a frame consisting of 30.25 bytes, as it is with HDLC. Not only can PPP frames be sent over dialup telephone lines, but they can also be sent over SONET or true bit-oriented HDLC lines (e.g., for router-router connections). The PPP frame format is shown in Fig.13.

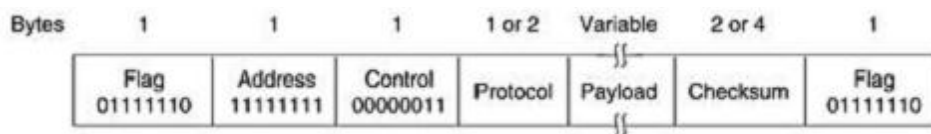

**Fig.13. The PPP full frame format for unnumbered mode operation**

All PPP frames begin with the standard HDLC flag byte (01111110), which is byte stuffed if it occurs within the payload field. Next comes the Address field, which is always set to the binary value 11111111 to indicate that all stations are to accept the frame. Using this value avoids the issue of having to assign data link addresses.

The Address field is followed by the Control field, the default value of which is 00000011. This value indicates an unnumbered frame. In other words, PPP does not provide reliable transmission using sequence numbers and acknowledgements as the default. In noisy environments, such as wireless networks, reliable transmission using numbered mode can be used. The exact details are defined in RFC 1663, but in practice it is rarely used. Since the Address and Control fields are always constant in the default configuration, LCP provides the necessary mechanism for the two parties to negotiate an option to just omit them altogether and save 2 bytes per frame.

The fourth PPP field is the Protocol field. Its job is to tell what kind of packet is in the Payload field. Codes are defined for LCP, NCP, IP, IPX, AppleTalk, and other protocols. Protocols starting with a 0 bit are network layer protocols such as IP, IPX, OSI CLNP, XNS. Those starting with a 1 bit are used to negotiate other protocols. These include LCP and a different NCP for each network layer protocol supported. The default size of the Protocol field is 2 bytes, but it can be negotiated down to 1 byte using LCP. The Payload field is variable length, up to some negotiated maximum. If the length is not negotiated using LCP during line setup, a default length of 1500 bytes is used. Padding may follow the payload if need be. After the Payload field comes the Checksum field, which is normally 2 bytes, but a 4-byte checksum can be negotiated.

In summary, PPP is a multiprotocol framing mechanism suitable for use over modems, HDLC bit-serial lines, SONET, and other physical layers. It supports error detection, option negotiation, header compression, and, optionally, reliable transmission using an HDLC type frame format.

## UNIT – V

### 5.1 Random Access:

#### 5.1.1 ALOHA:

In the 1970s, Norman Abramson and his colleagues at the University of Hawaii devised a new and elegant method to solve the channel allocation problem. Their work has been extended by many researchers since then (Abramson, 1985).

Although Abramson's work, called the ALOHA system, used ground-based radio broadcasting, the basic idea is applicable to any system in which uncoordinated users are competing for the use of a single shared channel. There are two versions of ALOHA: pure and slotted. They differ with respect to whether time is divided into discrete slots into which all frames must fit. Pure ALOHA does not require global time synchronization; slotted ALOHA does.

#### Pure ALOHA:

The basic idea of an ALOHA system is simple: let users transmit whenever they have data to be sent. There will be collisions, of course, and the colliding frames will be damaged. However, due to the feedback property of broadcasting, a sender can always find out whether its frame was destroyed by listening to the channel, the same way other users do. With a LAN, the feedback is immediate; with a satellite, there is a delay of 270 msec before the sender knows if the transmission was successful. If listening while transmitting is not possible for some reason, acknowledgements are needed. If the frame was destroyed, the sender just waits a random amount of time and sends it again. The waiting time must be random or the same frames will collide over and over, in lockstep. Systems in which multiple users share a common channel in a way that can lead to conflicts are widely known as contention systems.

A sketch of frame generation in an ALOHA system is given in Fig.1. We have made the frames all the same length because the throughput of ALOHA systems is maximized by having a uniform frame size rather than by allowing variable length frames.

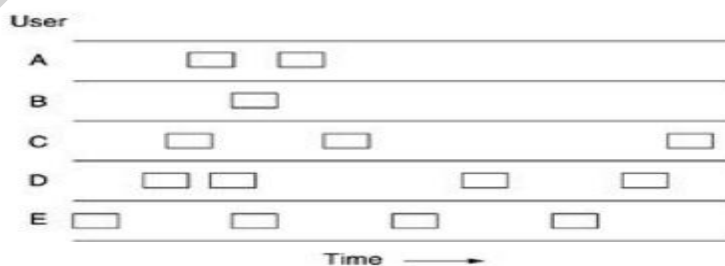

**Fig.1 In pure ALOHA, frames are transmitted at completely arbitrary times.**

Whenever two frames try to occupy the channel at the same time, there will be a collision and both will be garbled. If the first bit of a new frame overlaps with just the last bit of a frame almost finished, both frames will be totally destroyed and both will have to be retransmitted later. The checksum cannot (and should not) distinguish between a total loss and a near miss.

Let the "frame time" denote the amount of time needed to transmit the standard, fixed length frame (i.e., the frame length divided by the bit rate). At this point we assume that the infinite population of users generates new frames according to a Poisson distribution with mean  $N$  frames per frame time. (The infinite-population assumption is needed to ensure that  $N$  does not decrease as users become blocked.) If  $N > 1$ , the user community is generating frames at a higher rate than the channel can handle, and nearly every frame will suffer a collision. For reasonable throughput we would expect  $0 < N < 1$ . In addition to the new frames, the stations also generate retransmissions of frames that previously suffered collisions. Let us further assume that the probability of  $k$  transmission attempts per frame time, old and new combined, is also Poisson, with mean  $G$  per frame time. Clearly,  $G \geq N$ . At low load (i.e.,  $N \rightarrow 0$ ), there will be few collisions, hence few retransmissions, so  $G \approx N$ . At high load there will be many collisions, so  $G \gg N$ . Under all loads, the throughput,  $S$ , is just the offered load,  $G$ , times the probability,  $P_0$ , of a transmission succeeding—that is,  $S = GP_0$ , where  $P_0$  is the probability that a frame does not suffer a collision.

A frame will not suffer a collision if no other frames are sent within one frame time of its start, as shown in Fig.2.

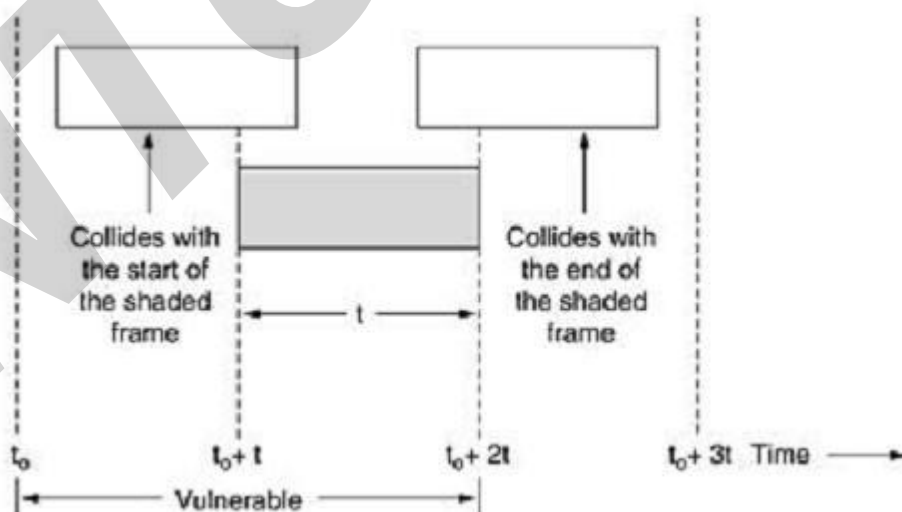

Fig.2. Vulnerable period for the shaded frame

Under what conditions will the shaded frame arrive undamaged? Let  $t$  be the time required to send a frame. If any other user has generated a frame between time  $t_0$  and  $t_0+t$ , the end of that frame will collide with the beginning of the shaded one. In fact, the shaded frame's fate was already sealed even before the first bit was sent, but since in pure ALOHA a station does not listen to the channel before transmitting, it has no way of knowing that another frame was already underway. Similarly, any other frame started between  $t_0+t$  and  $t_0+2t$  will bump into the end of the shaded frame.

The probability that  $k$  frames are generated during a given frame time is given by the Poisson distribution:

### Equation

$$\Pr[k] = \frac{G^k e^{-G}}{k!}$$

so the probability of zero frames is just  $e^{-G}$ . In an interval two frame times long, the mean number of frames generated is  $2G$ . The probability of no other traffic being initiated during the entire vulnerable period is thus given by  $P_0 = e^{-2G}$ . Using  $S = GP_0$ , we get

$$S = Ge^{-2G}$$

The relation between the offered traffic and the throughput is shown in Fig. 4-3. The maximum throughput occurs at  $G = 0.5$ , with  $S = 1/2e$ , which is about 0.184. In other words, the best we can hope for is a channel utilization of 18 per cent. This result is not very encouraging, but with everyone transmitting at will, we could hardly have expected a 100 per cent success rate.

### Slotted ALOHA:

In 1972, Roberts published a method for doubling the capacity of an ALOHA system (Robert, 1972). His proposal was to divide time into discrete intervals, each interval corresponding to one frame. This approach requires the users to agree on slot boundaries. One way to achieve synchronization would be to have one special station emit a pip at the start of each interval, like a clock.

In Roberts' method, which has come to be known as slotted ALOHA, in contrast to Abramson's pure ALOHA, a computer is not permitted to send whenever a carriage return is typed. Instead, it is required to wait for the beginning of the next slot. Thus, the continuous pure ALOHA is turned

into a discrete one. Since the vulnerable period is now halved, the probability of no other traffic during the same slot as our test frame is  $e^{-G}$  which leads to

**Equation**

$$S = Ge^{-G}$$

As you can see from Fig.3, slotted ALOHA peaks at  $G = 1$ , with a throughput of  $S=1/e$  or about 0.368, twice that of pure ALOHA. If the system is operating at  $G = 1$ , the probability of an empty slot is 0.368. The best we can hope for using slotted ALOHA is 37 percent of the slots empty, 37 percent successes, and 26 percent collisions. Operating at higher values of  $G$  reduces the number of empties but increases the number of collisions exponentially.

To see how this rapid growth of collisions with  $G$  comes about, consider the transmission of a test frame. The probability that it will avoid a collision is  $e^{-G}$ , the probability that all the other users are silent in that slot. The probability of a collision is then just  $1 - e^{-G}$ . The probability of a transmission requiring exactly  $k$  attempts, (i.e.,  $k - 1$  collisions followed by one success) is

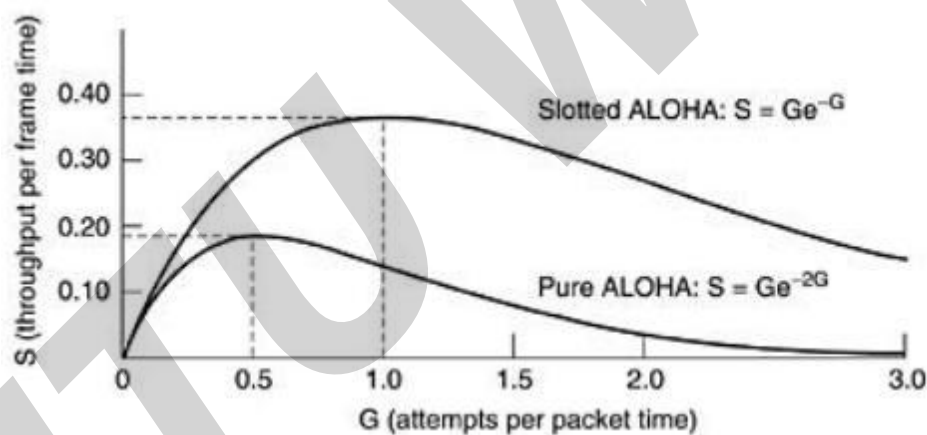

**Fig.3 Throughput versus offered traffic for ALOHA systems.**

$$P_k = e^{-G}(1 - e^{-G})^{k-1}$$

The expected number of transmissions,  $E$ , per carriage return typed is then

$$E = \sum_{k=1}^{\infty} kP_k = \sum_{k=1}^{\infty} ke^{-G}(1 - e^{-G})^{k-1} = e^G$$

As a result of the exponential dependence of  $E$  upon  $G$ , small increases in the channel load can drastically reduce its performance.

## 5.1.2 CSMA

### Carrier Sense Multiple Access Protocols:

With slotted ALOHA the best channel utilization that can be achieved is  $1/e$ . This is hardly surprising, since with stations transmitting at will, without paying attention to what the other stations are doing, there are bound to be many collisions. In local area networks, however, it is possible for stations to detect what other stations are doing, and adapt their behaviour accordingly. These networks can achieve a much better utilization than  $1/e$ . In this section we will discuss some protocols for improving performance. Protocols in which stations listen for a carrier (i.e., a transmission) and act accordingly are called carrier sense protocols. A number of them have been proposed. Kleinrock and Tobagi (1975) have analysed several such protocols in detail. Below we will mention several versions of the carrier sense protocols.

#### 1.1-persistent CSMA:

The first carrier sense protocol that we will study here is called **1-persistent CSMA** (Carrier Sense Multiple Access). When a station has data to send, it first listens to the channel to see if anyone else is transmitting at that moment. If the channel is busy, the station waits until it becomes idle. When the station detects an idle channel, it transmits a frame. If a collision occurs, the station waits a random amount of time and starts all over again. The protocol is called 1-persistent because the station transmits with a probability of 1 when it finds the channel idle.

The propagation delay has an important effect on the performance of the protocol. There is a small chance that just after a station begins sending, another station will become ready to send and sense the channel. If the first station's signal has not yet reached the second one, the latter will sense an idle channel and will also begin sending, resulting in a collision. The longer the propagation delay, the more important this effect becomes, and the worse the performance of the protocol. Even if the propagation delay is zero, there will still be collisions. If two stations become ready in the middle of a third station's transmission, both will wait politely until the transmission ends and then both will begin transmitting exactly simultaneously, resulting in a collision. If they were not so impatient, there would be fewer collisions. Even so, this protocol is far better than pure ALOHA because both stations have the decency to desist from interfering with the third station's frame. Intuitively, this approach will lead to a higher performance than pure ALOHA. Exactly the same holds for slotted ALOHA.

## 2. Non-persistent CSMA:

A second carrier sense protocol is **nonpersistent CSMA**. In this protocol, a conscious attempt is made to be less greedy than in the previous one. Before sending, a station senses the channel. If no one else is sending, the station begins doing so itself. However, if the channel is already in use, the station does not continually sense it for the purpose of seizing it immediately upon detecting the end of the previous transmission. Instead, it waits a random period of time and then repeats the algorithm. Consequently, this algorithm leads to better channel utilization but longer delays than 1-persistent CSMA.

## 3. P-persistent CSMA:

The last protocol is **p-persistent CSMA**. It applies to slotted channels and works as follows. When a station becomes ready to send, it senses the channel. If it is idle, it transmits with a probability  $p$ . With a probability  $q = 1 - p$ , it defers until the next slot. If that slot is also idle, it either transmits or defers again, with probabilities  $p$  and  $q$ . This process is repeated until either the frame has been transmitted or another station has begun transmitting. In the latter case, the unlucky station acts as if there had been a collision (i.e., it waits a random time and starts again). If the station initially senses the channel busy, it waits until the next slot and applies the above algorithm. Figure 4 shows the computed throughput versus offered traffic for all three protocols, as well as for pure and slotted ALOHA.

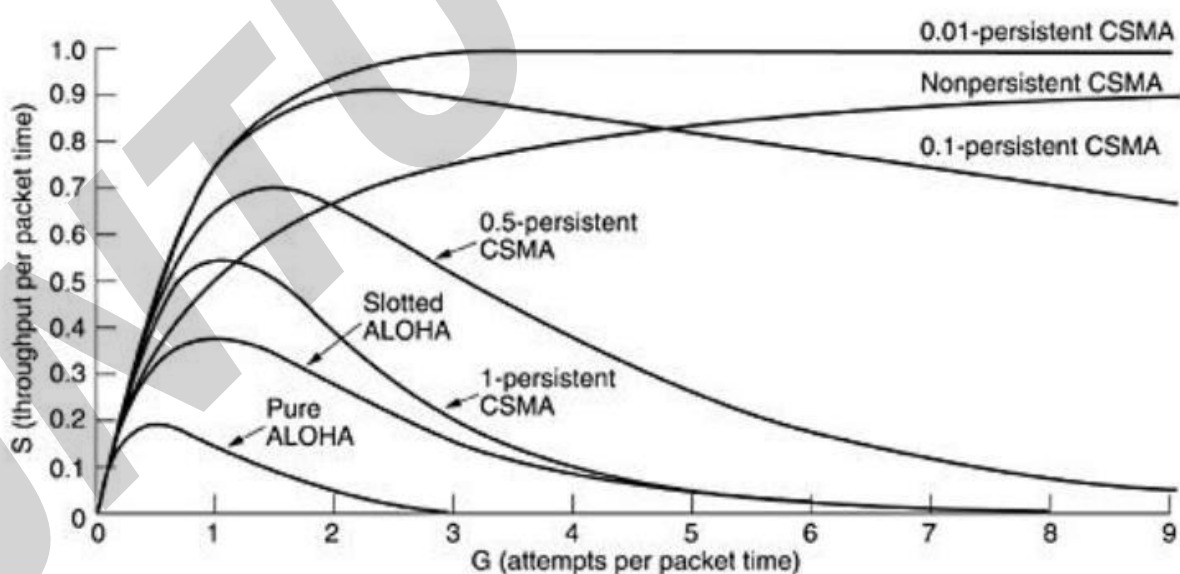

**Fig.4 Comparison of the channel utilization versus load for various random access protocols**



### 5.1.3 CSMA with Collision Detection:

Persistent and nonpersistent CSMA protocols are clearly an improvement over ALOHA because they ensure that no station begins to transmit when it senses the channel busy. Another improvement is for stations to abort their transmissions as soon as they detect a collision. In other words, if two stations sense the channel to be idle and begin transmitting simultaneously, they will both detect the collision almost immediately. Rather than finish transmitting their frames, which are irretrievably garbled anyway, they should abruptly stop transmitting as soon as the collision is detected. Quickly terminating damaged frames saves time and bandwidth.

This protocol, known as CSMA/CD (CSMA with Collision Detection) is widely used on LANs in the MAC sublayer. In particular, it is the basis of the popular Ethernet LAN, so it is worth devoting some time to looking at it in detail. CSMA/CD, as well as many other LAN protocols, uses the conceptual model of Fig.5. At the point marked  $t_0$ , a station has finished transmitting its frame. Any other station having a frame to send may now attempt to do so. If two or more stations decide to transmit simultaneously, there will be a collision. Collisions can be detected by looking at the power or pulse width of the received signal and comparing it to the transmitted signal.

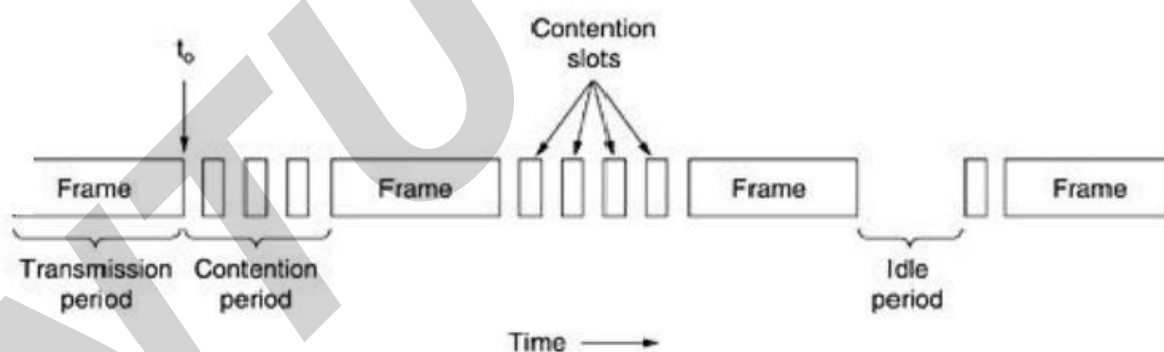

**Fig.5. CSMA/CD can be in one of three states: contention, transmission, or idle**

After a station detects a collision, it aborts its transmission, waits a random period of time, and then tries again, assuming that no other station has started transmitting in the meantime. Therefore, our model for CSMA/CD will consist of alternating contention and transmission periods, with idle periods occurring when all stations are quiet (e.g., for lack of work).

Now let us look closely at the details of the contention algorithm. Suppose that two stations both begin transmitting at exactly time  $t_0$ . How long will it take them to realize that there has been a collision? The answer to this question is vital to determining the length of the contention period and hence what the delay and throughput will be. The minimum time to detect the collision is then just the time it takes the signal to propagate from one station to the other.

Based on this reasoning, you might think that a station not hearing a collision for a time equal to the full cable propagation time after starting its transmission could be sure it had seized the cable. By "seized," we mean that all other stations knew it was transmitting and would not interfere. This conclusion is wrong. Consider the following worst-case scenario. Let the time for a signal to propagate between the two farthest stations be  $\tau$ . At  $t_0$ , one station begins transmitting. At  $t_0 + \tau$ , an instant before the signal arrives at the most distant station, that station also begins transmitting. Of course, it detects the collision almost instantly and stops, but the little noise burst caused by the collision does not get back to the original station until time  $t_0 + 2\tau$ . In other words, in the worst case a station cannot be sure that it has seized the channel until it has transmitted for  $2\tau$  without hearing a collision. For this reason we will model the contention interval as a slotted ALOHA system with slot width  $2\tau$ . On a 1-km long coaxial cable,  $\tau \approx 5 \mu\text{s}$ . For simplicity we will assume that each slot contains just 1 bit. Once the channel has been seized, a station can transmit at any rate it wants to, of course, not just at 1 bit per sec.

## UNIT-6

### 6.1 IEEE STANDARDS

In 1985, the Computer Society of the IEEE started a project, called Project 802, to set standards to enable intercommunication among equipment from a variety of manufacturers. Project 802 does not seek to replace any part of the OSI or the Internet model. Instead, it is a way of specifying functions of the physical layer and the data link layer of major LAN protocols.

The standard was adopted by the American National Standards Institute (ANSI). In 1987, the International Organization for Standardization (ISO) also approved it as an international standard under the designation ISO 8802. The relationship of the 802 Standard to the traditional OSI model is shown in Figure 1.

The IEEE has subdivided the data link layer into two sublayers:

logical link control (LLC) and media access control (MAC).

IEEE has also created several physical layer standards for different LAN protocols.

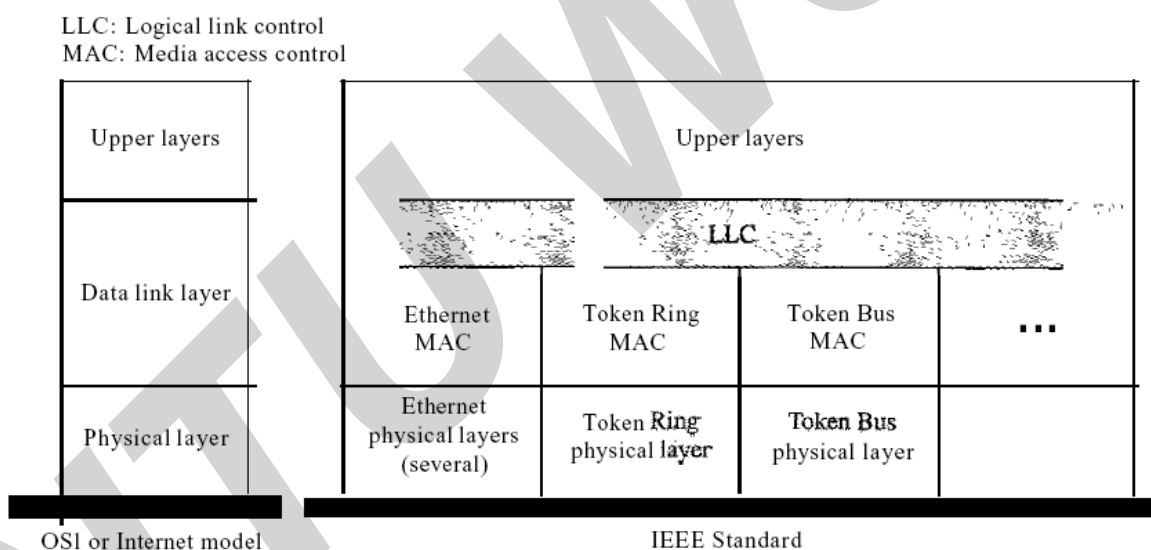

Figure 1 *IEEE standard for LANs*

#### 6.1.1 Data Link Layer

As we mentioned before, the data link layer in the IEEE standard is divided into two sublayers: LLC and MAC.

### Logical Link Control (LLC)

We said that data link control handles framing, flow control, and error control. In IEEE Project 802, flow control, error control, and part of the framing duties are collected into one sublayer called the logical link control. Framing is handled in both the LLC sublayer and the MAC sublayer.

The LLC provides one single data link control protocol for all IEEE LANs. In this way, the LLC is different from the media access control sublayer, which provides different protocols for different LANs. A single LLC protocol can provide interconnectivity between different LANs because it makes the MAC sublayer transparent. Figure 1 shows one single LLC protocol serving several MAC protocols. Framing LLC defines a protocol data unit (PDU) that is somewhat similar to that of HDLC. The header contains a control field like the one in HDLC; this field is used for flow and error control. The two other header fields define the upper-layer protocol at the source and destination that uses LLC. These fields are called the destination service access point (DSAP) and the source service access point (SSAP). The other fields defined in a typical data link control protocol such as HDLC are moved to the MAC sublayer. In other words, a frame defined in HDLC is divided into a PDU at the LLC sublayer and a frame at the MAC sublayer, as shown in Figure 2.

**Need for LLC** The purpose of the LLC is to provide flow and error control for the upper-layer protocols that actually demand these services. For example, if a LAN or several LANs are used in an isolated system, LLC may be needed to provide flow and error control for the application layer protocols. However, most upper-layer protocols such as IP, do not use the services of LLC.

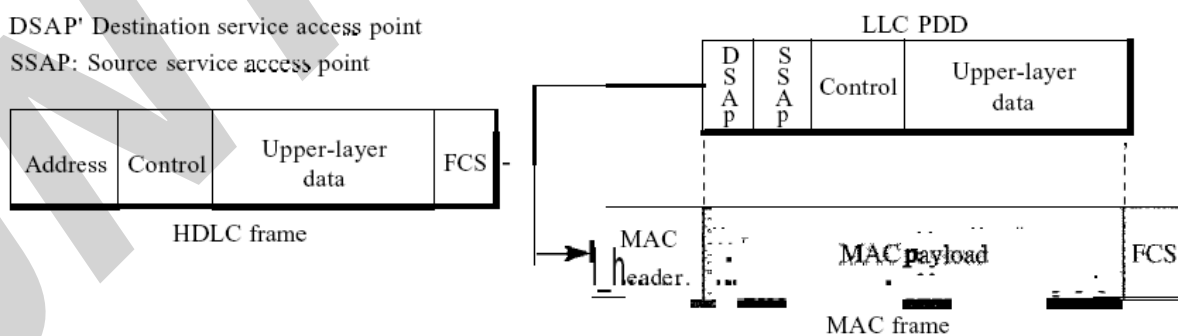

Figure 13.2 HDLC frame compared with LLC and MAC frames

### *Media Access Control (MAC)*

IEEE Project 802 has created a sublayer called media access control that defines the specific access method for each LAN. For example, it defines *CSMA/CD* as the media access method for Ethernet LANs and the tokenpassing method for Token Ring and Token Bus LANs. As we discussed in the previous section, part of the framing function is also handled by the MAC layer. In contrast to the LLC sublayer, the MAC sublayer contains a number of distinct modules; each defines the access method and the framing format specific to the corresponding LAN protocol.

#### **6.1.2 Physical Layer**

The physical layer is dependent on the implementation and type of physical media used. IEEE defines detailed specifications for each LAN implementation. For example, although there is only one MAC sublayer for Standard Ethernet, there is a different physical layer specifications for each Ethernet implementations.

### **6.2 Standard Ethernet**

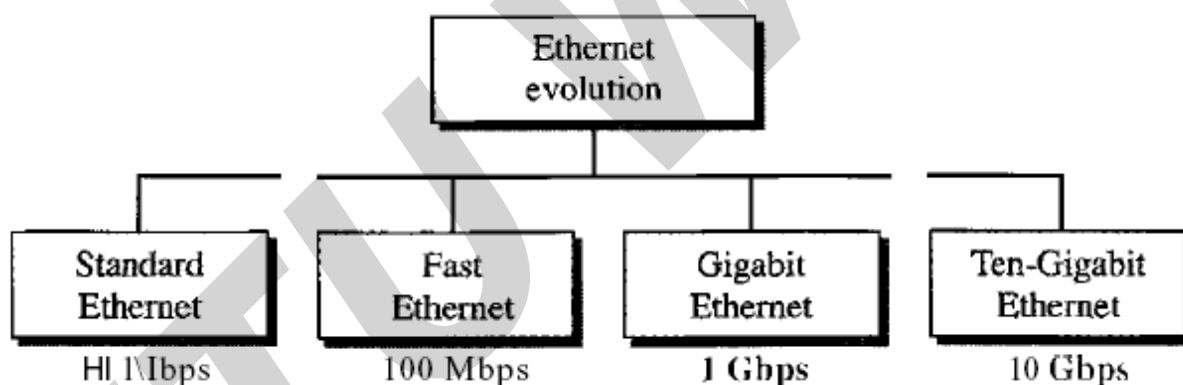

Figure 3 *Ethernet evolution through four generations*

#### **6.2.1 MAC Sublayer**

In Standard Ethernet, the MAC sublayer governs the operation of the access method. It also frames data received from the upper layer and passes them to the physical layer.

##### *Frame Format*

The Ethernet frame contains seven fields: preamble, SFD, DA, SA, length or type of protocol data unit (PDU), upper-layer data, and the CRE. Ethernet does not provide any mechanism for acknowledging received frames, making it what is known as an unreliable medium.

Acknowledgments must be implemented at the higher layers. The format of the MAC frame is shown in Figure 4.

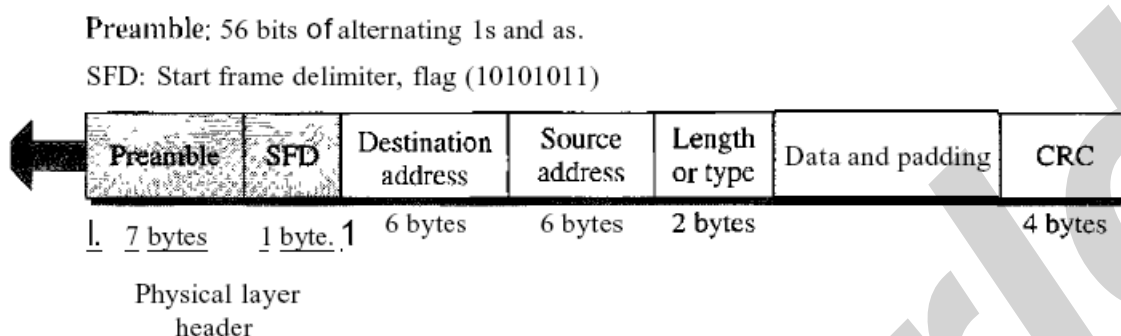

Figure 4 802.3 MAC frame

- **Preamble.** The first field of the 802.3 frame contains 7 bytes (56 bits) of alternating 0s and 1s that alerts the receiving system to the coming frame and enables it to synchronize its input timing. The pattern provides only an alert and a timing pulse. The 56-bit pattern allows the stations to miss some bits at the beginning of the frame. The preamble is actually added at the physical layer and is not (formally) part of the frame.
- **Start frame delimiter (SFD).** The second field (1 byte: 10101011) signals the beginning of the frame. The SFD warns the station or stations that this is the last chance for synchronization. The last 2 bits are 11 and alerts the receiver that the next field is the destination address.
- **Destination address (DA).** The DA field is 6 bytes and contains the physical address of the destination station or stations to receive the packet.
- **Source address (SA).** The SA field is also 6 bytes and contains the physical address of the sender of the packet. We will discuss addressing shortly.
- **Length or type.** This field is defined as a type field or length field. The original Ethernet used this field as the type field to define the upper-layer protocol using the MAC frame. The IEEE standard used it as the length field to define the number of bytes in the data field. Both uses are common today.
- **Data.** This field carries data encapsulated from the upper-layer protocols. It is a minimum of 46 and a maximum of 1500 bytes.
- **CRC.** The last field contains error detection information, in this case a CRC-32

### Frame Length

Ethernet has imposed restrictions on both the minimum and maximum lengths of a frame, as shown in Figure 5.

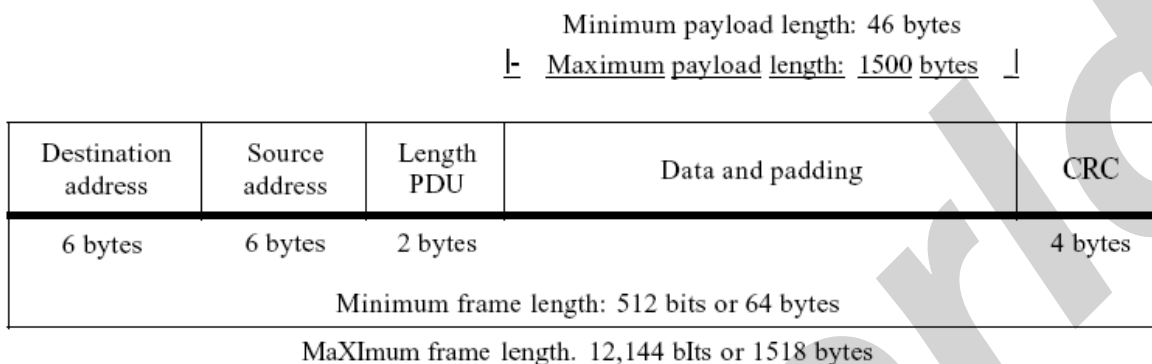

Figure 5 *Minimum and maximum lengths*

The minimum length restriction is required for the correct operation of *CSMA/CD*. An Ethernet frame needs to have a minimum length of 512 bits or 64 bytes. Part of this length is the header and the trailer. If we count 18 bytes of header and trailer (6 bytes of source address, 6 bytes of destination address, 2 bytes of length or type, and 4 bytes of CRC), then the minimum length of data from the upper layer is  $64 - 18 = 46$  bytes. If the upper-layer packet is less than 46 bytes, padding is added to make up the difference.

The standard defines the maximum length of a frame (without preamble and SFD field) as 1518 bytes. If we subtract the 18 bytes of header and trailer, the maximum length of the payload is 1500 bytes. The maximum length restriction has two historical reasons. First, memory was very expensive when Ethernet was designed: a maximum length restriction helped to reduce the size of the buffer. Second, the maximum length restriction prevents one station from monopolizing the shared medium, blocking other stations that have data to send.

Frame length:

Minimum: 64 bytes (512 bits) Maximum: 1518 bytes (12,144 bits)

### Addressing

Each station on an Ethernet network (such as a PC, workstation, or printer) has its own network interface card (NIC). The NIC fits inside the station and provides the station with a 6-byte

physical address. As shown in Figure 6, the Ethernet address is 6 bytes (48 bits), normally written in hexadecimal notation, with a colon between the bytes.

06:01:02:01:2C:4B  
6 bytes = 12 hex digits = 48 bits

Figure 6 Example of an Ethernet address in hexadecimal notation

Unicast, Multicast, and Broadcast Addresses A source address is always a unicast address—the frame comes from only one station. The destination address, however, can be unicast, multicast, or broadcast. Figure 7 shows how to distinguish a unicast address from a multicast address. If the least significant bit of the first byte in a destination address is 0, the address is unicast; otherwise, it is multicast.

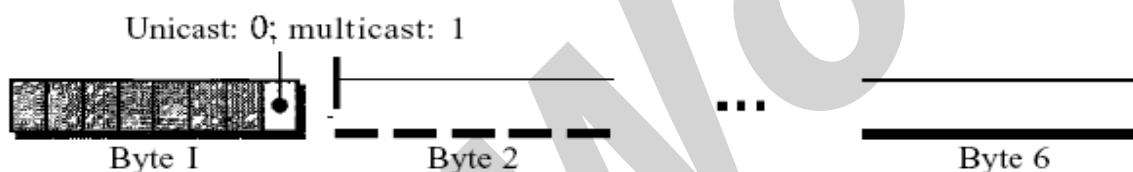

Figure 7 Unicast and multicast addresses

A unicast destination address defines only one recipient; the relationship between the sender and the receiver is one-to-one. A multicast destination address defines a group of addresses; the relationship between the sender and the receivers is one-to-many. The broadcast address is a special case of the multicast address; the recipients are all the stations on the LAN. A broadcast destination address is forty-eight.

### 6.2.2 Physical Layer

The Standard Ethernet defines several physical layer implementations; four of the most common, are shown in Figure 8.

#### *Encoding and Decoding*

All standard implementations use digital signaling (baseband) at 10 Mbps. At the sender, data are converted to a digital signal using the Manchester scheme; at the receiver, the received signal is interpreted as Manchester and decoded into data. Manchester encoding is self-synchronous, providing a transition at each bit interval. Figure 9 shows the encoding scheme for Standard Ethernet.



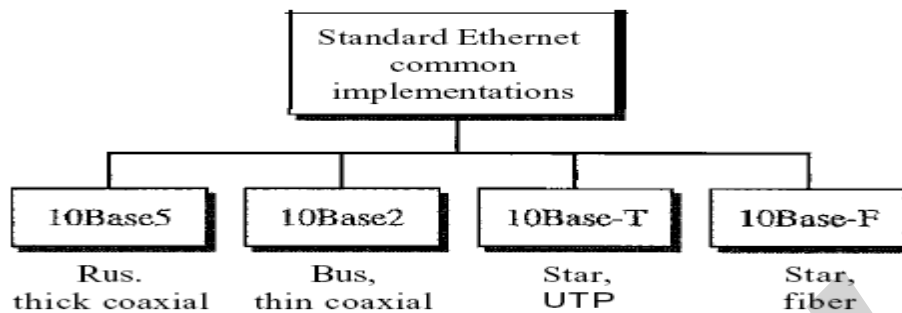

**Figure 8** Categories of Standard Ethernet

### 6.3 Fast Ethernet

Fast Ethernet was designed to compete with LAN protocols such as FDDI or Fiber Channel (or Fibre Channel, as it is sometimes spelled). IEEE created Fast Ethernet under the name 802.3u. Fast Ethernet is backward-compatible with Standard Ethernet, but it can transmit data 10 times faster at a rate of 100 Mbps.

The goals of Fast Ethernet can be summarized as follows:

1. Upgrade the data rate to 100 Mbps.
2. Make it compatible with Standard Ethernet.
3. Keep the same 48-bit address.
4. Keep the same frame format.
5. Keep the same minimum and maximum frame lengths.

- **MAC Sublayer**
- **Physical Layer**

### 6.4 IEEE 802.11

#### 6.4.1 Architecture

The standard defines two kinds of services: the basic service set (BSS) and the extended service set (ESS).

##### *Basic Service Set*

IEEE 802.11 defines the basic service set (BSS) as the building block of a wireless LAN. A basic service set is made of stationary or mobile wireless stations and an optional central base station, known as the access point (AP). Figure 9 shows two sets in this standard.

The BSS without an AP is a stand-alone network and cannot send data to other BSSs. It is called an *ad hoc architecture*. In this architecture, stations can form a network without the need of an

AP; they can locate one another and agree to be part of a BSS. A BSS with an AP is sometimes referred to as an *infrastructure* network.

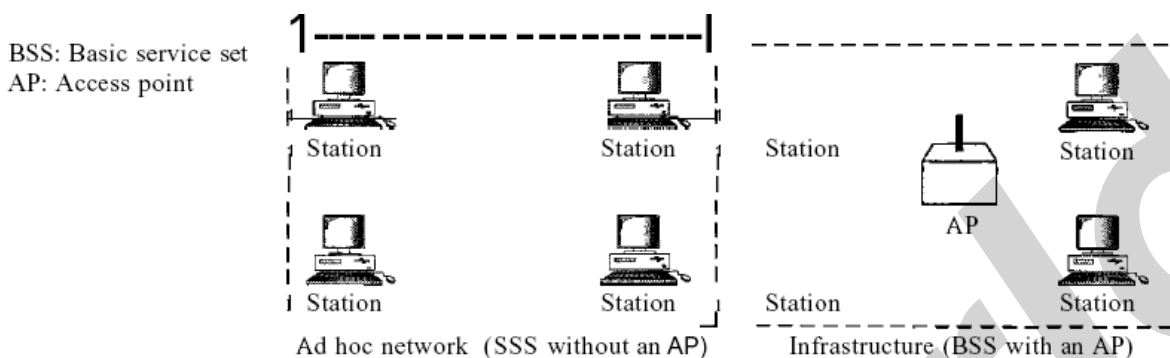

Figure. 9 Basic service sets (BSSs)

### Extended Service Set

An extended service set (ESS) is made up of two or more BSSs with APs. In this case, the BSSs are connected through a *distribution system*, which is usually a wired LAN. The distribution system connects the APs in the BSSs. IEEE 802.11 does not restrict the distribution system; it can be any IEEE LAN such as an Ethernet. Note that the extended service set uses two types of stations: mobile and stationary. The mobile stations are normal stations inside a BSS. The stationary stations are AP stations that are part of a wired LAN. Figure 10 shows an ESS.

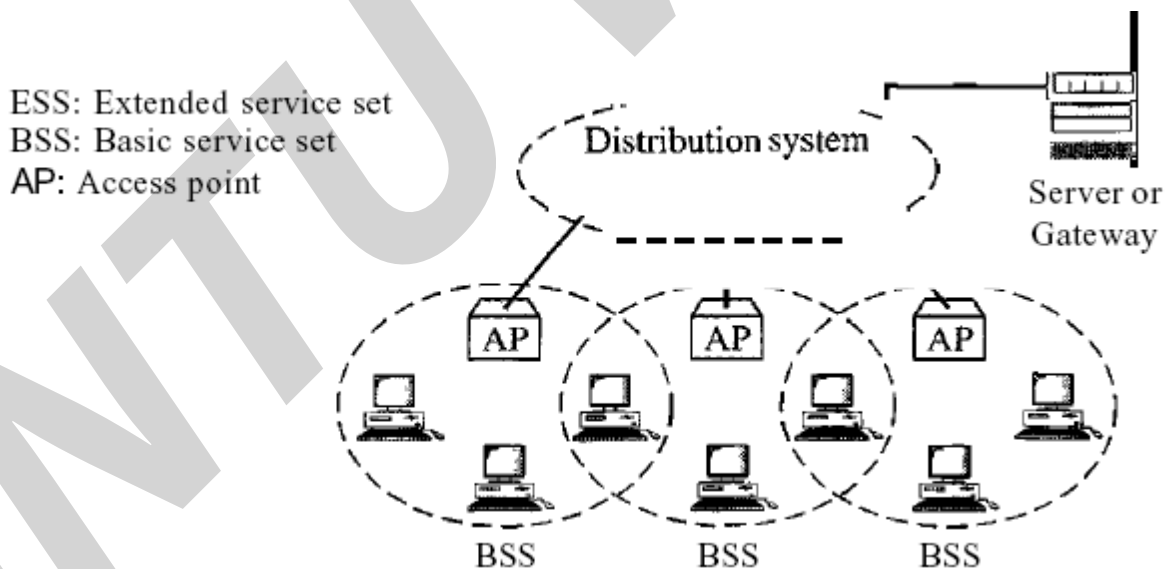

Figure 10 Extended service sets (ESSs)

## UNIT-7

### 7.1 Bluetooth:

Bluetooth is a wireless LAN technology designed to connect devices of different functions such as telephones, notebooks, computers (desktop and laptop), cameras, printers, coffee makers, and so on. A Bluetooth LAN is an ad hoc network, which means that the network is formed spontaneously; the devices, sometimes called gadgets, find each other and make a network called a piconet. A Bluetooth LAN can even be connected to the Internet if one of the gadgets has this capability. A Bluetooth LAN, by nature, cannot be large. If there are many gadgets that try to connect, there is chaos.

Bluetooth technology has several applications. Peripheral devices such as a wireless mouse or keyboard can communicate with the computer through this technology. Monitoring devices can communicate with sensor devices in a small health care center. Home security devices can use this technology to connect different sensors to the main security controller. Conference attendees can synchronize their laptop computers at a conference.

Bluetooth was originally started as a project by the Ericsson Company. It is named for Harald Blaatand, the king of Denmark (940-981) who united Denmark and Norway. *Blaatand* translates to *Bluetooth* in English.

Today, Bluetooth technology is the implementation of a protocol defined by the IEEE 802.15 standard. The standard defines a wireless personal-area network (PAN) operable in an area the size of a room or a hall.

#### 7.1.1 Architecture

Bluetooth defines two types of networks: piconet and scatternet.

##### *Piconets*

A Bluetooth network is called a piconet, or a small net. A piconet can have up to eight stations, one of which is called the primary; the rest are called secondaries. All the secondary stations synchronize their clocks and hopping sequence with the primary. Note that a piconet can have only one primary station. The communication between the primary and the secondary can be one-to-one or one-to-many. Figure 1 shows a piconet.

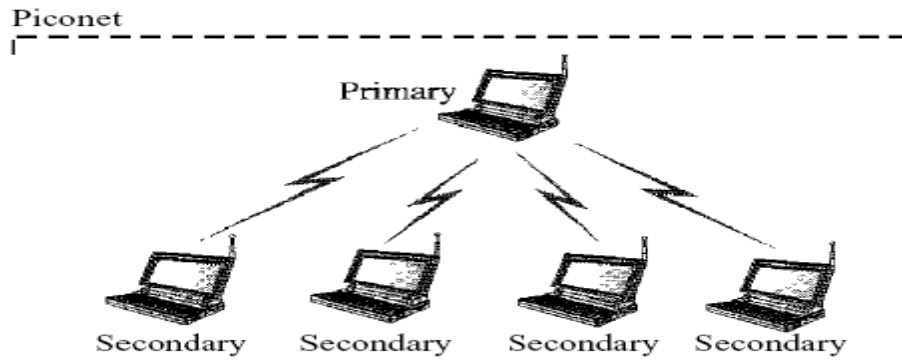

Figure 1 Piconet

Although a piconet can have a maximum of seven secondaries, an additional eight secondaries can be in the *parked state*. A secondary in a parked state is synchronized with the primary, but cannot take part in communication until it is moved from the parked state. Because only eight stations can be active in a piconet, activating a station from the parked state means that an active station must go to the parked state.

#### Scat/ernet

Piconets can be combined to form what is called a scatternet. A secondary station in one piconet can be the primary in another piconet. This station can receive messages from the primary in the first piconet (as a secondary) and, acting as a primary, deliver them to secondaries in the second piconet. A station can be a member of two piconets.

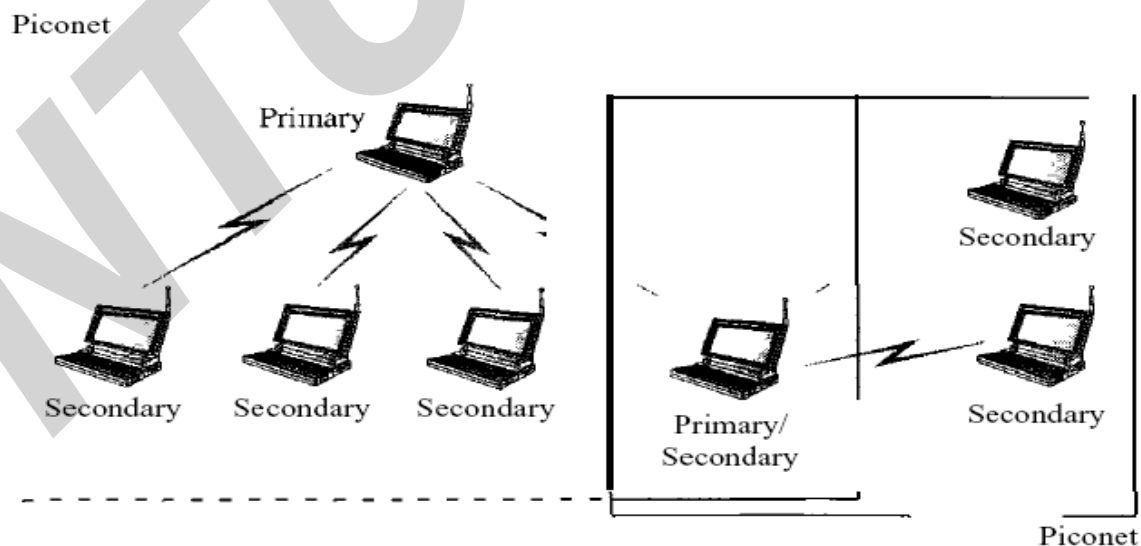

Figure 2 illustrates a scatternet.

### Bluetooth Devices

A Bluetooth device has a built-in short-range radio transmitter. The current data rate is 1 Mbps with a 2.4-GHz bandwidth. This means that there is a possibility of interference between the IEEE 802.11b wireless LANs and Bluetooth LANs.

#### 7.1.2 Bluetooth Layers

Bluetooth uses several layers that do not exactly match those of the Internet model we have defined in this book. Figure 3 shows these layers.

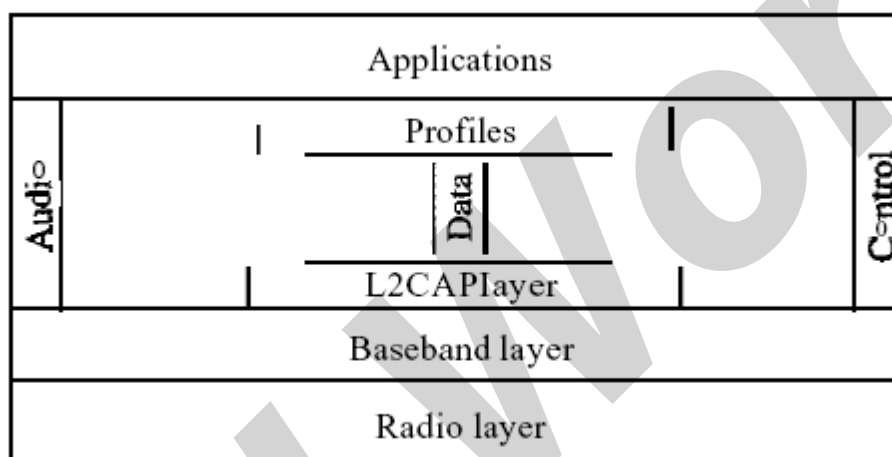

Figure 3 Bluetooth layers

#### Radio Layer

The radio layer is roughly equivalent to the physical layer of the Internet model. Bluetooth devices are low-power and have a range of 10 m.

#### Band

Bluetooth uses a 2.4-GHz ISM band divided into 79 channels of 1 MHz each.

#### FHSS

Bluetooth uses the frequency-hopping spread spectrum (FHSS) method in the physical layer to avoid interference from other devices or other networks. Bluetooth hops 1600 times per second, which means that each device changes its modulation frequency 1600 times per second. A device uses a frequency for only 625 ns (1/1600 s) before it hops to another frequency; the dwell time is 625 ns.

### *Modulation*

To transform bits to a signal, Bluetooth uses a sophisticated version of FSK, called GFSK (FSK with Gaussian bandwidth filtering; a discussion of this topic is beyond the scope of this book). GFSK has a carrier frequency. Bit 1 is represented by a frequency deviation above the carrier; bit 0 is represented by a frequency deviation below the carrier. The frequencies, in megahertz, are defined according to the following formula for each channel:

$$f_c = 2402 + n \quad n = 0, 1, 2, 3, \dots, 78$$

For example, the first channel uses carrier frequency 2402 MHz (2.402 GHz), and the second channel uses carrier frequency 2403 MHz (2.403 GHz).

### *Baseband Layer*

The baseband layer is roughly equivalent to the MAC sublayer in LANs. The access method is TDMA (see Chapter 12). The primary and secondary communicate with each other using time slots. The length of a time slot is exactly the same as the dwell time, 625  $\mu$ s. This means that during the time that one frequency is used, a sender sends a frame to a secondary, or a secondary sends a frame to the primary. Note that the communication is only between the primary and a secondary; secondaries cannot communicate directly with one another.

### *TDMA*

Bluetooth uses a form of TDMA (see Chapter 12) that is called TDD-TDMA (time-division duplex TDMA). TDD-TDMA is a kind of half-duplex communication in which the secondary and receiver send and receive data, but not at the same time (half-duplex); however, the communication for each direction uses different hops. This is similar to walkie-talkies using different carrier frequencies.

**Single-Secondary Communication** If the piconet has only one secondary, the TDMA operation is very simple. The time is divided into slots of 625  $\mu$ s. The primary uses even-numbered slots (0, 2, 4, ...); the secondary uses odd-numbered slots (1, 3, 5, ...). TDD-TDMA allows the primary and the secondary to communicate in half-duplex mode.

In slot 0, the primary sends, and the secondary receives; in slot 1, the secondary sends, and the primary receives. The cycle is repeated. Figure 4 shows the concept.

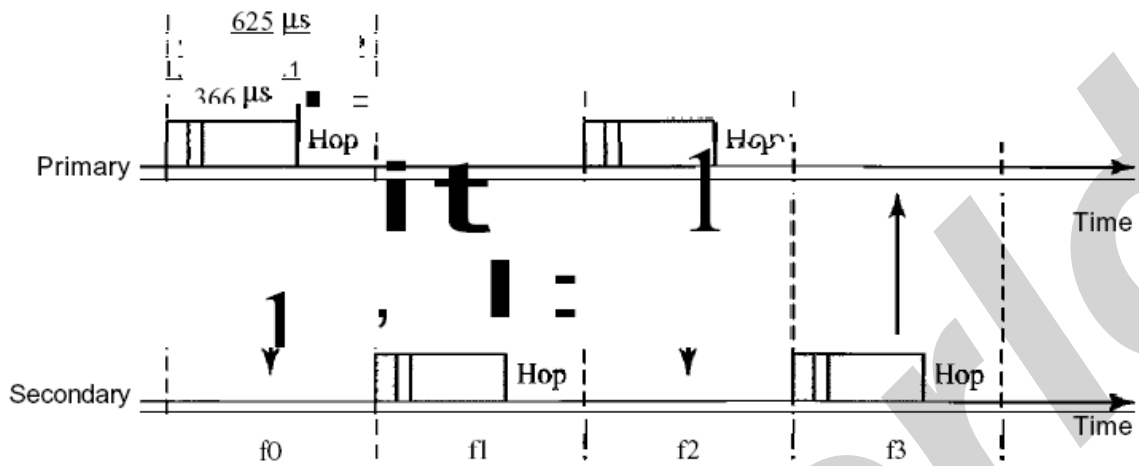

Figure 4 Single-secondary communication

## UNIT – VIII

### 8. Data Link Layer Switching

#### 8.1 Bridges:

Many organizations have multiple LANs and wish to connect them. LANs can be connected by devices called bridges, which operate in the data link layer. Bridges examine the data layer link addresses to do routing. Some common situations in which bridges are used.

First, many university and corporate departments have their own LANs, primarily to connect their own personal computers, workstations, and servers. Since the goals of the various departments differ, different departments choose different LANs, without regard to what other departments are doing. Sooner or later, there is a need for interaction, so bridges are needed. In this example, multiple LANs came into existence due to the autonomy of their owners.

Second, the organization may be geographically spread over several buildings separated by considerable distances. It may be cheaper to have separate LANs in each building and connect them with bridges and laser links than to run a single cable over the entire site.

Third, it may be necessary to split what is logically a single LAN into separate LANs to accommodate the load. At many universities, for example, thousands of workstations are available for student and faculty computing. Files are normally kept on file server machines and are downloaded to users' machines upon request. The enormous scale of this system precludes putting all the workstations on a single LAN—the total bandwidth needed is far too high. Instead, multiple LANs connected by bridges are used, as shown in Fig.17.1. Each LAN contains a cluster of workstations with its own file server so that most traffic is restricted to a single LAN and does not add load to the backbone.

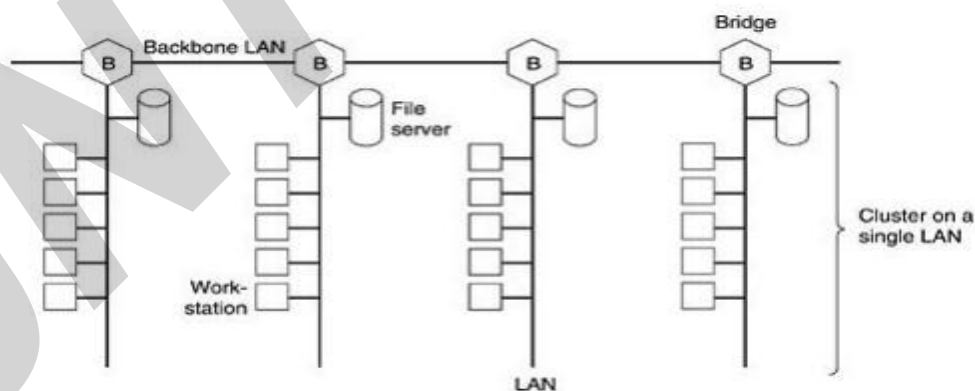

**Fig.1 Multiple LANs connected by a backbone to handle a total load higher than the capacity of a single LAN.**



It is worth noting that although we usually draw LANs as multi drop cables as in Fig.1(the classic look), they are more often implemented with hubs or especially switches nowadays. However, a long multi drop cable with multiple machines plugged into it and a hub with the machines connected inside the hub are functionally identical. In both cases, all the machines belong to the same collision domain, and all use the CSMA/CD protocol to send frames.

Fourth, in some situations, a single LAN would be adequate in terms of the load, but the physical distance between the most distant machines is too great (e.g., more than 2.5 km for Ethernet). Even if laying the cable is easy to do, the network would not work due to the excessively long round-trip delay. The only solution is to partition the LAN and install bridges between the segments. Using bridges, the total physical distance covered can be increased.

Fifth, there is the matter of reliability. On a single LAN, a defective node that keeps outputting a continuous stream of garbage can cripple the LAN. Bridges can be inserted at critical places, like fire doors in a building, to prevent a single node that has gone berserk from bringing down the entire system. Unlike a repeater, which just copies whatever it sees, a bridge can be programmed to exercise some discretion about what it forwards and what it does not forward.

Sixth, and last, bridges can contribute to the organization's security. Most LAN interfaces have a promiscuous mode, in which all frames are given to the computer, not just those addressed to it. Spies and busybodies love this feature. By inserting bridges at various places and being careful not to forward sensitive traffic, a system administrator can isolate parts of the network so that its traffic cannot escape and fall into the wrong hands.

## **8.2 Operation of Two Port Bridge:**

Fig.2 illustrates the operation of a simple two-port bridge. Host A on a wireless (802.11) LAN has a packet to send to a fixed host, B, on an (802.3) Ethernet to which the wireless LAN is connected. The packet descends into the LLC sublayer and acquires an LLC header (shown in black in the figure). Then it passes into the MAC sublayer and an 802.11 header is prepended to it (also a trailer, not shown in the figure). This unit goes out over the air and is picked up by the base station, which sees that it needs to go to the fixed Ethernet.

When it hits the bridge connecting the 802.11 network to the 802.3 network, it starts in the physical layer and works its way upward. In the MAC sublayer in the bridge, the 802.11 header is stripped off. The bare packet (with LLC header) is then handed off to the LLC sublayer in the bridge. In this example, the packet is destined for an 802.3 LAN, so it works its way down the

802.3 side of the bridge and off it goes on the Ethernet. Note that a bridge connecting  $k$  different LANs will have  $k$  different MAC sublayers and  $k$  different physical layers, one for each type.

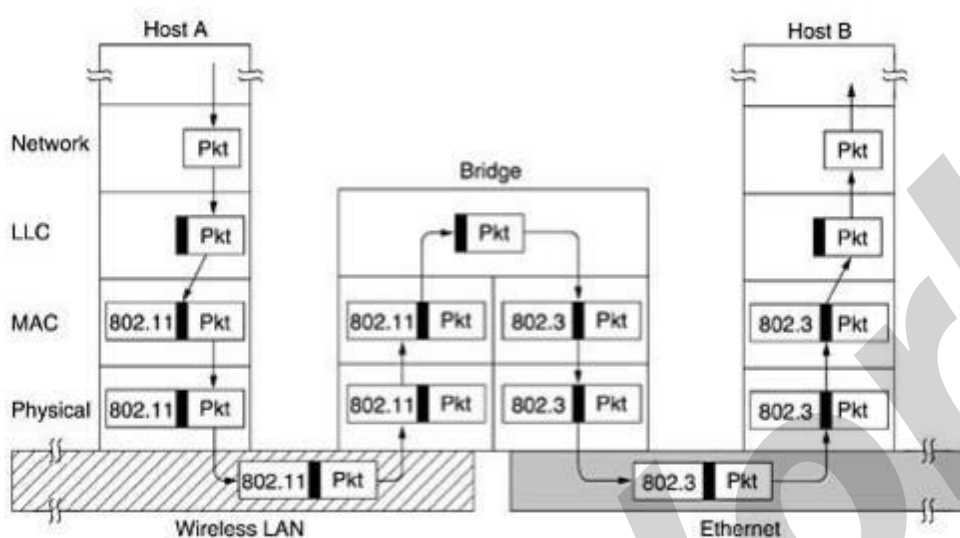

**Fig.2 Operation of a LAN bridge from 802.11 to 802.3 Spanning Tree Bridges:**

To increase reliability, some sites use two or more bridges in parallel between pairs of LANs, as shown in Fig.3. This arrangement, however, also introduces some additional problems because it creates loops in the topology. A simple example of these problems can be seen by observing how a frame,  $F$ , with unknown destination is handled in Fig.17.3. Each bridge, following the normal rules for handling unknown destinations, uses flooding, which in this example just means copying it to LAN 2. Shortly thereafter, bridge 1 sees  $F_2$ , a frame with an unknown destination, which it copies to LAN 1, generating  $F_3$  (not shown). Similarly, bridge 2 copies  $F_1$  to LAN 1 generating  $F_4$  (also not shown). Bridge 1 now forwards  $F_4$  and bridge 2 copies  $F_3$ . This cycle goes on forever.

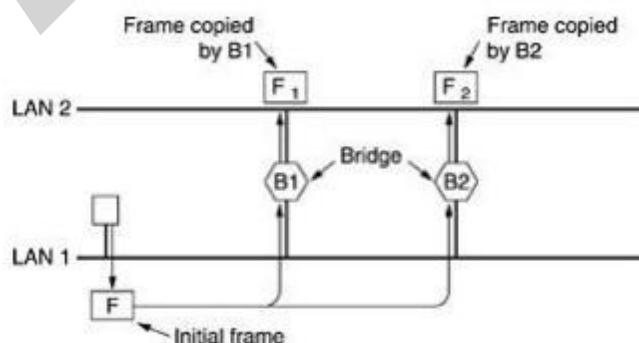

**Fig.3. Two parallel transparent bridges.**

The solution to this difficulty is for the bridges to communicate with each other and overlay the actual topology with a spanning tree that reaches every LAN. In effect, some potential connections between LANs are ignored in the interest of constructing a fictitious loop-free topology. For example, in Fig.4 (a) we see nine LANs interconnected by ten bridges. This configuration can be abstracted into a graph with the LANs as the nodes. An arc connects any two LANs that are connected by a bridge. The graph can be reduced to a spanning tree by dropping the arcs shown as dotted lines in Fig.4 (b). Using this spanning tree, there is exactly one path from every LAN to every other LAN. Once the bridges have agreed on the spanning tree, all forwarding between LANs follows the spanning tree. Since there is a unique path from each source to each destination, loops are impossible.

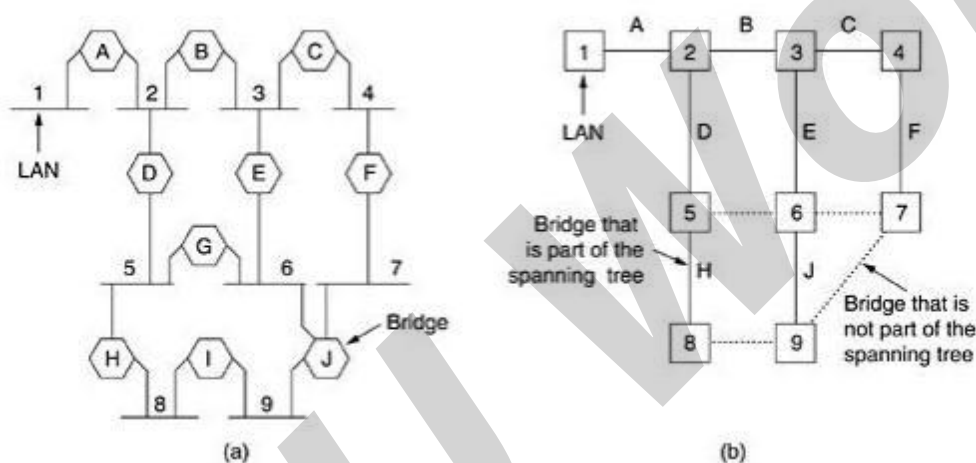

**Fig.4 (a) Interconnected LANs. (b) A spanning tree covering the LANs. The dotted lines are not part of the spanning tree.**

To build the spanning tree, first the bridges have to choose one bridge to be the root of the tree. They make this choice by having each one broadcast its serial number, installed by the manufacturer and guaranteed to be unique worldwide. The bridge with the lowest serial number becomes the root. Next, a tree of shortest paths from the root to every bridge and LAN is constructed. This tree is the spanning tree. If a bridge or LAN fails, a new one is computed.

The result of this algorithm is that a unique path is established from every LAN to the root and thus to every other LAN. Although the tree spans all the LANs, not all the bridges are necessarily present in the tree (to prevent loops). Even after the spanning tree has been established, the algorithm continues to run during normal operation in order to automatically detect topology changes and update the tree.

### 8.3 Remote Bridges:

A common use of bridges is to connect two (or more) distant LANs. For example, a company might have plants in several cities, each with its own LAN. Ideally, all the LANs should be interconnected, so the complete system acts like one large LAN. This goal can be achieved by putting a bridge on each LAN and connecting the bridges pairwise with point-to-point lines (e.g., lines leased from a telephone company). A simple system, with three LANs, is illustrated in Fig.5. The usual routing algorithms apply here. The simplest way to see this is to regard the three point-to-point lines as hostless LANs. Then we have a normal system of six LANs interconnected by four bridges.

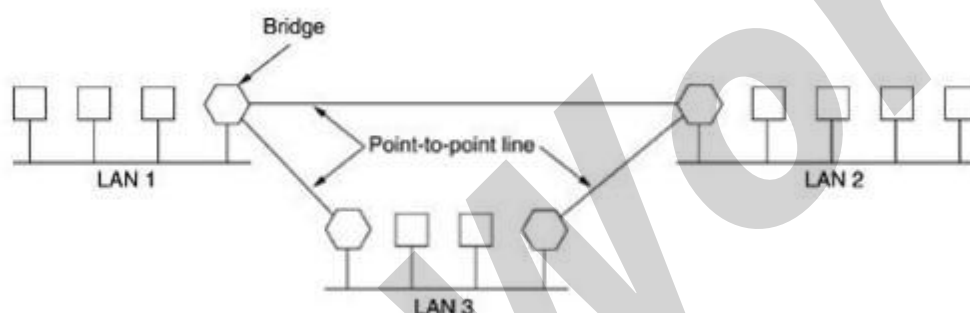

**Fig.5. Remote bridges can be used to interconnect distant LANs.**

Various protocols can be used on the point-to-point lines. One possibility is to choose some standard point-to-point data link protocol such as PPP, putting complete MAC frames in the payload field. This strategy works best if all the LANs are identical, and the only problem is getting frames to the correct LAN. Another option is to strip off the MAC header and trailer at the source bridge and put what is left in the payload field of the point-to-point protocol. A new MAC header and trailer can then be generated at the destination bridge. A disadvantage of this approach is that the checksum that arrives at the destination host is not the one computed by the source host, so errors caused by bad bits in a bridge's memory may not be detected.

### 8.4 Virtual LANs

A station is considered part of a LAN if it physically belongs to that LAN. The criterion of membership is geographic. What happens if we need a virtual connection between two stations belonging to two different physical LANs? We can roughly define a virtual local area network (VLAN) as a local area network configured by software, not by physical wiring.

Let us use an example to elaborate on this definition. Figure 6 shows a switched LAN in an engineering firm in which 10 stations are grouped into three LANs that are connected by a switch. The first four engineers work together as the first group, the next three engineers work together as the second group, and the last three engineers work together as the third group. The LAN is configured to allow this arrangement.

But what would happen if the administrators needed to move two engineers from the first group to the third group, to speed up the project being done by the third group?

The LAN configuration would need to be changed. The network technician must rewire. The problem is repeated if, in another week, the two engineers move back to their previous group. In a switched LAN, changes in the work group mean physical changes in the network configuration.

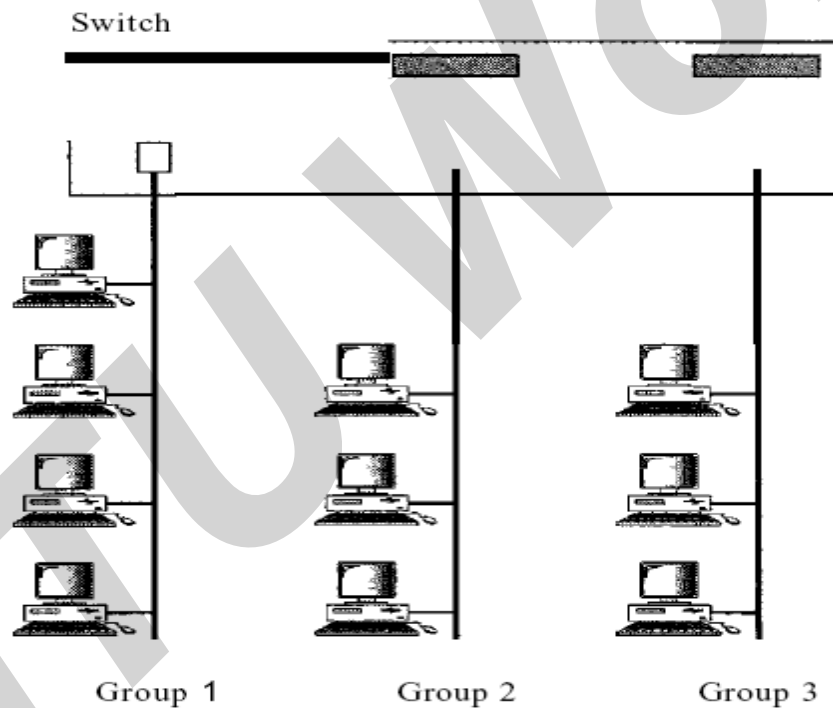

**Figure 6** A switch connecting three LANs